

INSTRUCTION MANUAL

DVD-SL25

DVD Player

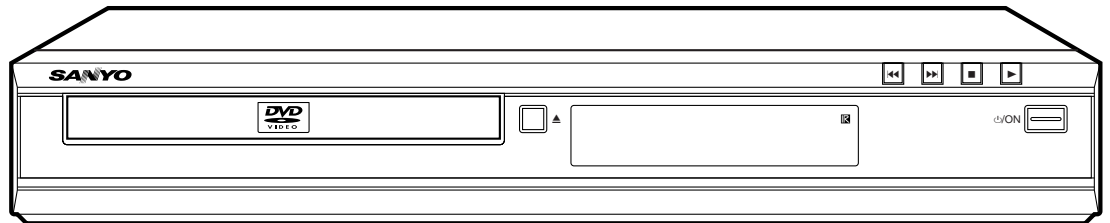
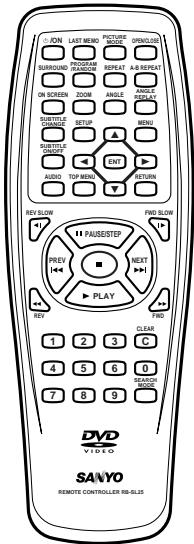

PRECAUTIONS

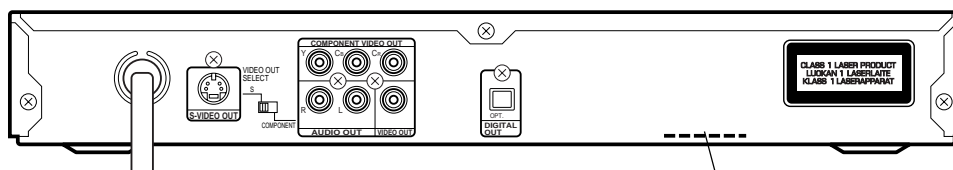

CAUTION – USE OF CONTROLS OR ADJUSTMENTS OR PERFORMANCE OF PROCEDURES OTHER THAN THOSE SPECIFIED IN THE OPERATING INSTRUCTIONS MAY RESULT IN HAZARDOUS RADIATION EXPOSURE. THIS UNIT SHOULD NOT BE ADJUSTED OR REPAIRED BY ANYONE EXCEPT PROPERLY QUALIFIED PERSONNEL.

CAUTION – INVISIBLE LASER RADIATION WHEN OPEN AND INTERLOCKS DEFEATED. AVOID EXPOSURE TO BEAM.
ADVARSEL – USYNLIG LASER STRÅLING VED ÅBNING, NÅR SIKKERHEDSAFBRYDERE ER UDE AF FUNKTION, UNDGÅ UDSÆTTELSE FOR STRÅLING.
VARNING – OSYNLIG LASER STRÅLNING NÅR DENNA DEL ÄR ÖPPNAD OCH SPÄRR ÄR URKOPPLAD. STRÅLEN ÄR FARLIG.
VORSICHT – UNSICHTBARE LASERSTRAHLUNG TRITT AUS, WENN DECKEL GEÖFFNET UND WENN SICHERHEITSPERRUNG ÜBERBRÜCKT IST. NICHT, DEM STRAHL AUSSETZEN.
VARO – AVATTAESSA JA SUOJALUKITUS OHITETTAESSA OLET ALTTIINA NÄKYMÄTTÖMÄLLE LASERSÄTEILYLLE. ÄLÄ KATSO SÄTEESEEN.



- The apparatus shall not be exposed to dripping or splashing.
- No objects filled with liquids, such as vases, shall be placed on the apparatus.
- Do not use where there are extremes of temperature (below 5°C or exceeding 35°C) or where direct sunlight may strike it.
- Because of the DVD player's extremely low noise and wide dynamic range, there might be a tendency to set the volume on the amplifier unnecessarily high. Doing so may produce an excessively large output from the amplifier which could damage your speakers.
- Sudden changes in the ambient temperature may cause condensation to form on the optical lens inside the unit. If this happens, take out the disc, leave the unit for about 1 hour, and then proceed to operate.
- When carrying the unit, be sure to remove a disc which may be inside and turn the power off. Wait at least 10 seconds, then unplug the mains lead from the AC outlet. Carrying the unit with a disc inside may damage the disc and/or the unit.
- Do not install this equipment in a confined space, such as a book case or built in cabinet.
- The unit is not completely disconnected from the mains when the ON button is set to the position.

- The unit is automatically set to the screen saver mode after approximately 15 minutes have elapsed under the stop or pause mode.
- The unit is automatically set to the standby mode after approximately 30 minutes have elapsed under the complete stop mode.

Important Information:

To connect this unit to a TV, TV must have a set of Audio/Video composite input sockets at least. You cannot use an RF input socket or aerial terminal to connect this unit.

This product incorporates copyright protection technology that is protected by method claims of certain U.S. patents and other intellectual property rights owned by Macrovision Corporation and other rights owners. Use of this copyright protection technology must be authorized by Macrovision Corporation, and is intended for home and other limited viewing uses only unless otherwise authorized by Macrovision Corporation. Reverse engineering or disassembly is prohibited.

CONTROLS

Front panel

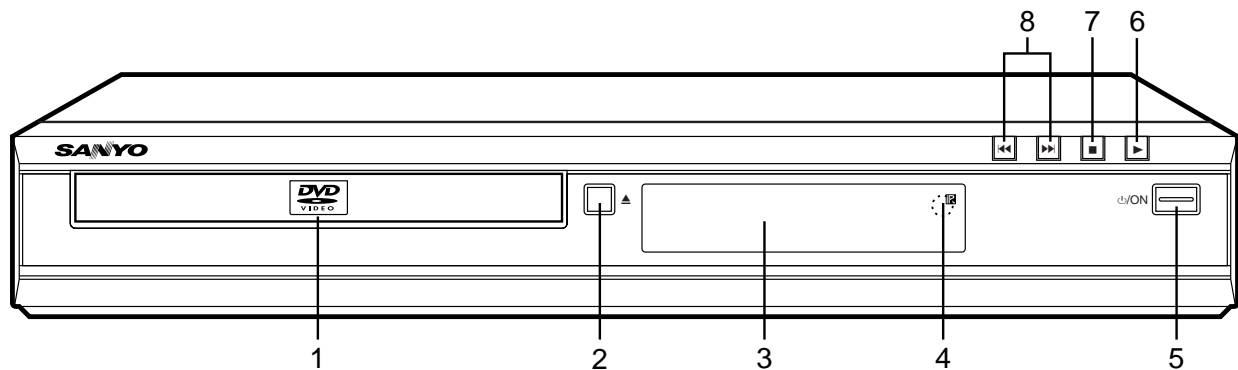

- | | |
|------------------------------------|--|
| 1. Disc tray | 5. Power button (ON/OFF) |
| 2. Disc tray open/close button (▲) | 6. Play button (▶) |
| 3. Display | 7. Stop button (■) |
| 4. Remote sensor (IR) | 8. Skip/Next/Previous buttons (◀◀, ▶▶) |

Display

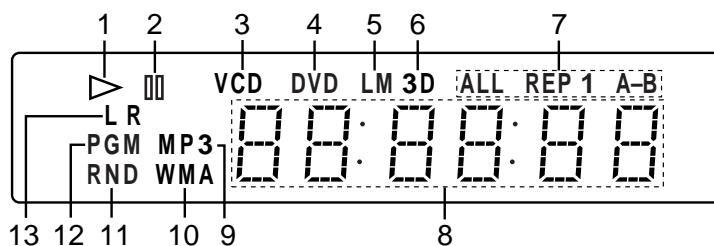

- | | |
|---|---|
| 1. Play indicator (▶) | 8. Message or number indicators
(Title, chapter, track, playing time or other information) |
| 2. Pause indicator (⏸) | 9. MP3 indicator (MP3) |
| 3. VCD/CD indicator (VCD/CD) | 10. WMA indicator (WMA) |
| 4. DVD indicator (DVD) | 11. Random play indicator (RND) |
| 5. Last memory indicator (LM) | 12. Programme indicator (PGM) |
| 6. Virtual surround sound indicator (3D) | 13. Audio channel indicator (L, R) |
| 7. Repeat mode indicators (ALL, REP 1, A-B) | |

Rear panel

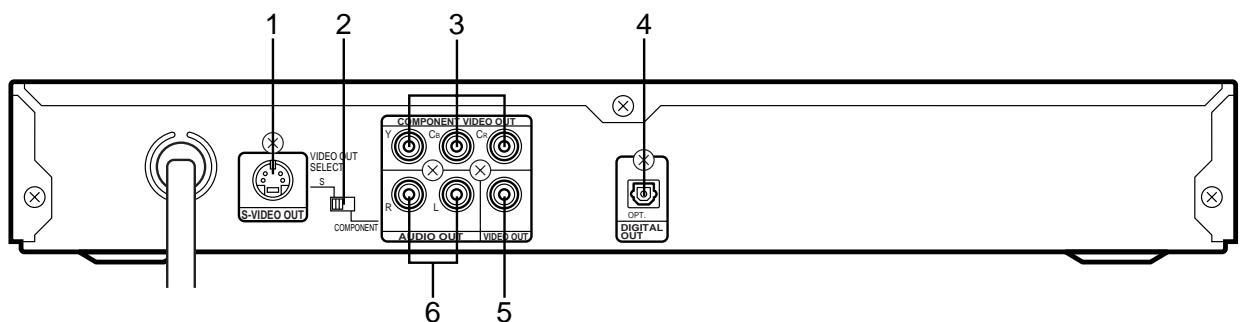

- | | |
|---|--|
| 1. S-Video output socket (S-VIDEO OUT) | 4. Optical digital output socket (DIGITAL OUT) |
| 2. Video output select switch (VIDEO OUT SELECT) | 5. Video output socket (VIDEO OUT) |
| 3. Component video output sockets (COMPONENT VIDEO OUT) | 6. Audio output sockets (AUDIO OUT) |

REMOTE CONTROL

Controls

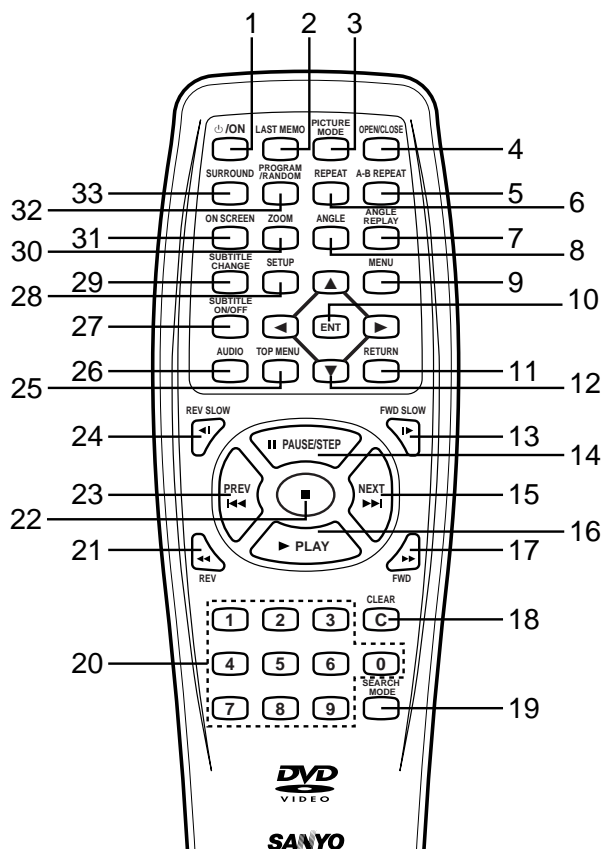

1. Power button (ON/OFF)
2. Last memory button (LAST MEMO)
3. Picture mode button (PICTURE MODE)
4. Open/Close button (OPEN/CLOSE)
5. A-B repeat button (A-B REPEAT)
6. Repeat button (REPEAT)
7. Angle replay button (ANGLE REPLAY)
8. Angle button (ANGLE)
9. Menu button (MENU)
10. Enter button (ENT)
11. Return button (RETURN)
12. Directional arrow buttons (▲, ▼, ◀, ▶)
13. Forward slow button (FWD SLOW ►)
14. Pause/Step button (|| PAUSE/STEP)
15. Skip/Next button (NEXT ►►)
16. Play button (► PLAY)
17. Forward button (►► FWD)
18. Clear button (CLEAR)
19. Search mode button (SEARCH MODE)
20. Number buttons (1 – 9, 0)
21. Reverse button (◀◀ REV)
22. Stop button (■)
23. Skip/Previous button (PREV ◀◀)
24. Reverse slow button (REV SLOW ◀)
25. Top menu button (TOP MENU)
26. Audio button (AUDIO)
27. Subtitle on/off button (SUBTITLE ON/OFF)
28. Setup button (SETUP)
29. Subtitle change button (SUBTITLE CHANGE)
30. Zoom button (ZOOM)
31. On screen display button (ON SCREEN)
32. Programme/Random play button (PROGRAM/RANDOM)
33. Surround sound button (SURROUND)

Inserting batteries

Install two "R6/AA" batteries (not supplied).

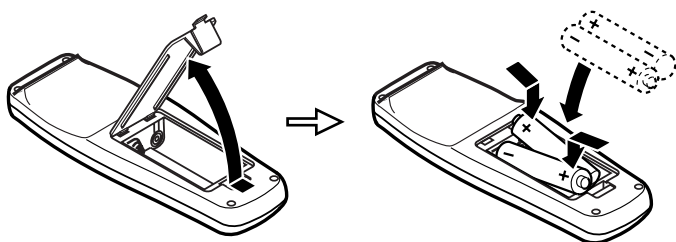

Note:
Remove the batteries if the remote control is not to be used for a month or more. Batteries left in the unit may leak and cause damage.

Remote control range

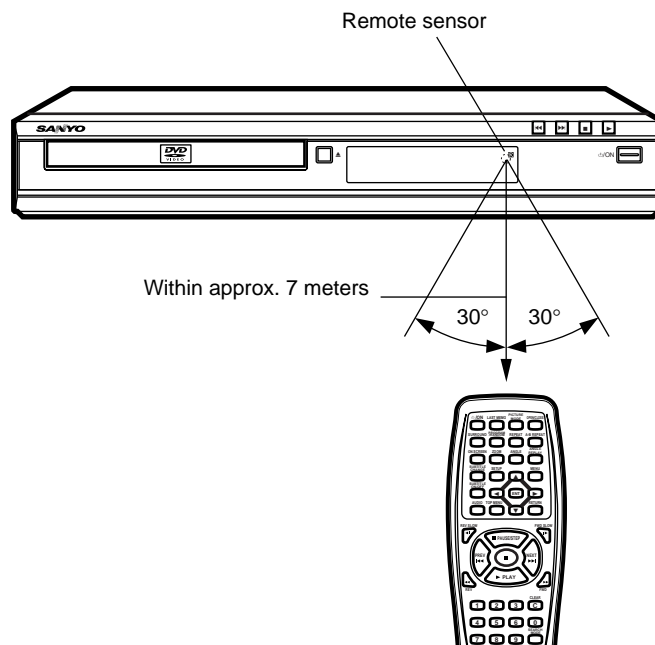

CONNECTIONS

Before connections

- Do not connect the unit to a VCR directly. The playback picture will be distorted because DVD discs are copy protected.
- When you connect the unit to your TV and other equipment, be sure to turn off the power and disconnect all of the equipments from the wall outlet until all the connections have been made.
- Please refer to the instruction manuals for the components that you are connecting (TV, AV amplifier, etc.).

Connecting to a TV with the audio/video lead

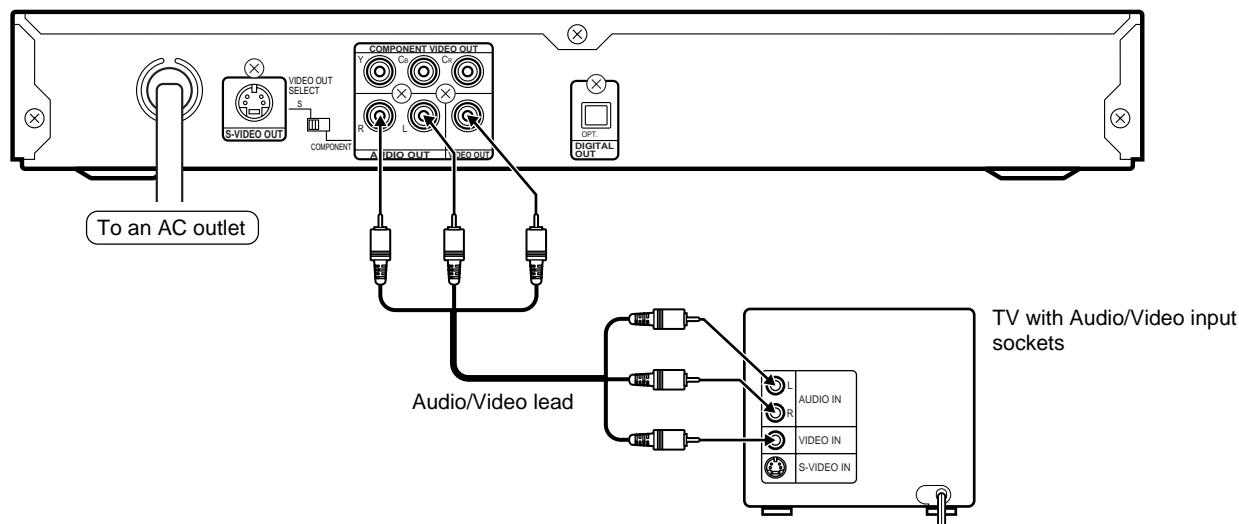

Connecting to a TV with an audio and S-video leads

Please follow these steps before turning on the power.

1. If your TV has an S-video input socket, connect the unit as shown in figure. (The VIDEO OUT socket connection is not necessary.) You can enjoy clearer picture playback.
2. Set the VIDEO OUT SELECT switch to S.

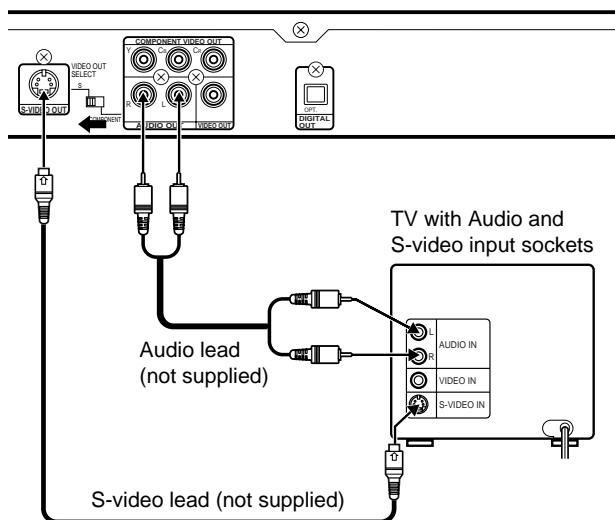

Connecting to a TV with an Audio and Component video leads

Please follow these steps before turning on the power.

1. If your TV has a component video input sockets, connect the unit as shown in figure. (The VIDEO OUT socket connection is not necessary.) You can enjoy clearer picture playback.
2. Set the VIDEO OUT SELECT switch to COMPONENT.

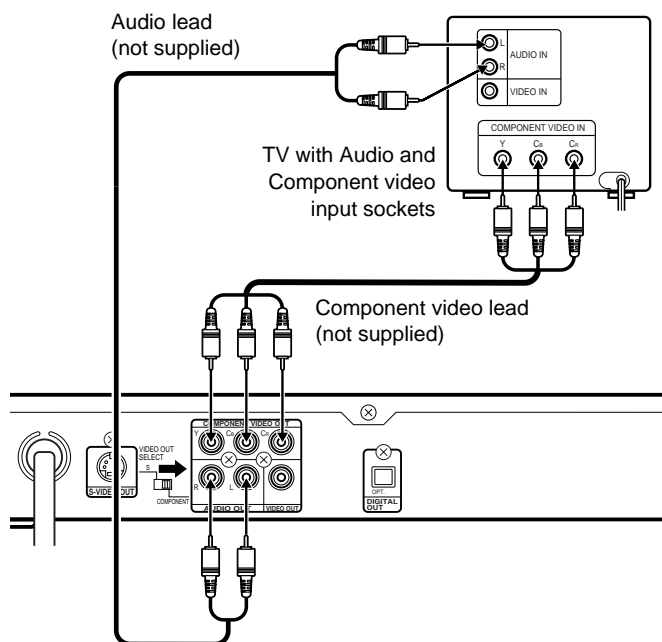

As an alternative to using the TV's speakers, the sound can also be played back through a HiFi system or an amplifier.

Connecting to a HiFi system with analog two-channel stereo sound

Connect an audio lead (not supplied) to the AUDIO OUT sockets of the unit and to the appropriate sockets of the HiFi system.

- The AUDIO OUT sockets can also be used for connection to an AV system with Dolby Pro Logic decoder.

Note:

To enjoy Dolby Pro Logic sound, select "Dolby Digital: LPCM" in "Setting digital out". (See Page 14.)

Connecting to a digital multi-channel AV amplifier

The digital multi-channel sound of a DVD can best be decoded and played with a multi-channel AV amplifier (Dolby Digital decoder or MPEG-2 decoder).

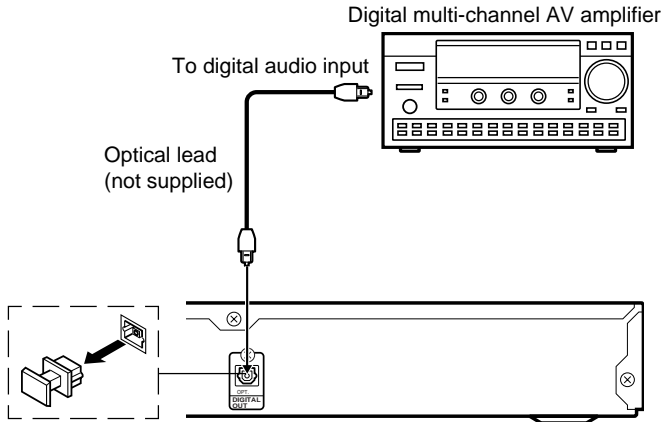

The AV amplifier has to be able to process the DTS audio signal in order to play a DVD with DTS. If it cannot, then you will not be able to hear the DVD.

Note:

Select "Setting digital out" setting as follows. (See Page 14.)

- To enjoy Dolby Digital sound, select "Dolby Digital: BitStream".
- To enjoy DTS sound, select "DTS: On".
- To enjoy MPEG-2 sound, select "MPEG: BitStream".
- To enjoy 2 channel digital stereo sound, select "Dolby Digital: LPCM", "DTS: Off", "MPEG: LPCM".

Notes on the digital socket connection

Before connecting, remove the protective cap from the DIGITAL OUT socket. Replace the cap if there is no device connected to this socket.

Manufactured under license from Dolby Laboratories.

"Dolby", "Pro Logic" and the double-D symbol are trademarks of Dolby Laboratories.

"DTS" and "DTS Digital Out" are trademarks of Digital Theater Systems, Inc.

PLAYABLE DISCS

The following types of discs can be played on this unit.

Disc type and logo mark	
DVD Video	
Audio CD	

Region number

Region number (Regional restriction code) is built-in to the unit and DVD discs.

There is a region number on the rear of the unit.

The same region number or region number "ALL" of DVD discs can be used on this unit.

DVD disc

There are the marks on some DVD disc packages.

Example:

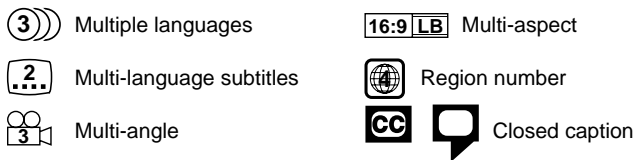

DVD discs are divided into titles, and the titles are sub-divided into chapters.

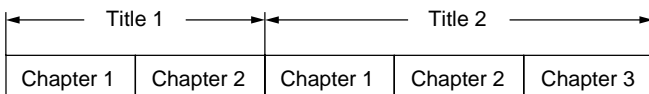

Video CD/Audio CD disc

Video CD/Audio CD discs are divided into tracks.

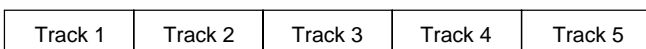

Note:

- Only the above types of discs can be played on this unit. DVD-ROM, CD-ROM, SVCD, CVD, etc. cannot be played.
- This unit can play back the Video CD (VCD).
- This unit can play back the DVD-R that has recorded movie data. However, some DVD-Rs cannot be played back depending on the recording conditions.
- The DVD-R that has no movie data cannot be played back.
- This unit is to be used exclusively with the PAL (or NTSC) colour system discs. SECAM system discs cannot be used with this unit.
- For DVD discs: The video output signal format can be selected ("PAL 60" or "NTSC") when playing back the NTSC discs.
- For MP3/WMA CD, please see Page 11.
- For Picture/JPEG CD, please see Page 12.

Notes on handling discs

- Do not expose the disc to direct sunlight, high humidity or high temperatures for extended periods of time.
- Discs should be returned to their cases after use.
- Do not apply paper or write anything on the disc surface.
- Handle the disc by its edge. Do not touch the playing surface (glossy side).
- Fingerprints and dust should be carefully wiped off the playing surface of the disc with a soft cloth. Wipe in a straight motion from the centre to the outside of the disc.
- Never use chemicals such as record cleaning sprays, antistatic sprays or fluids, benzene or thinner to clean discs.

BASIC OPERATION

Important note:

- This instruction manual explains the basic instruction of this unit using the remote control.
- Some DVD or VCD discs have different functions that may not be explained in this instruction manual. You may need extra instructions. In this case, please follow the instructions displayed on the TV screen or jacket or case of the disc.
- "⊘" may appear on the TV screen during operation. This icon means that the function is not available on the disc now.

Preparations

- Turn on the TV and select the video input for this unit.
Select the playback picture size according to the aspect ratio of the TV. (See "Setting display" on Page 13.)
- Turn on the AV amplifier, etc. and select the audio input for this unit.
- Select the desired language for the on-screen menus if required. The following languages can be selected.
English (default), Spanish, French, German, Portuguese
(See "Setting language" on Page 13.)

Note:

- Do not touch the disc tray while it is moving.
- Never place anything except a disc on the disc tray. Foreign objects can damage the unit.
- Do not apply excessive force to the disc tray.
- Only one disc must be placed on the disc tray at a time.
- To open or close the disc tray, be sure to use the OPEN/CLOSE (or ▲ on the main unit) button. Do not press the disc tray with your hand.

When operation buttons are pressed, that operation is displayed on the TV screen for several seconds.

1. Press the ⏻/ON button. "SANYO" logo appears on the TV screen. "-----" blinks, then "NO dISC" appears on the display.
2. Press the OPEN/CLOSE button. "OPEN" appears on the display and the disc tray opens.
 - When using the main unit, use the ▲ button.
3. Place the disc with the label facing up on the disc tray.

12 cm disc

8 cm disc

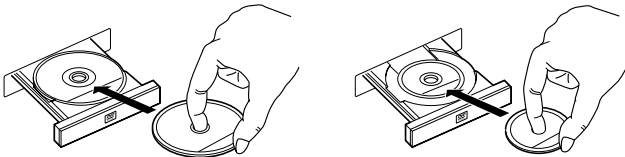

4. Press the OPEN/CLOSE button again. The disc tray closes.

Note:

Some discs may start play automatically.

Starting play

Press the ► PLAY button.

- When using the main unit, use the ► button.

Example:

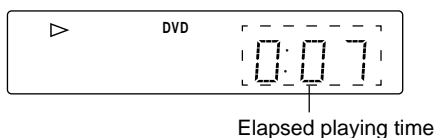

Note:

If the disc is loaded with the label side downward (and it is a single sided disc), or if a badly scratched disc is loaded, "No Play" appears. If this occurs, load the disc correctly or replace the disc.

If a menu appears on the TV screen...

Press the ▲, ►, ▼ or ◀ button (or the number buttons), then press the ENT button to select the desired menu. Playback of the selected menu starts.

Note:

For more details, please refer to the jacket or case of the disc.

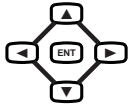

Stopping play

[DVD] [VCD]

- Press the ■ button once.
When you press the ► PLAY button, play starts automatically from the point where you stopped.

Note:

Some discs may not resume play.

- Press the ■ button twice. The unit stops completely and "StOP" appears on the display.
When you press the ► PLAY button, play starts from the beginning of the disc.

[CD]

- Press the ■ button. The unit stops completely.

To turn off the power, press the ⏻/ON button.

Continuing play from where you stopped watching (Last memory play) [DVD]

1. During play, press the LAST MEMO button at the point from which you want to resume play later. "LM StOP" appears on the display. Play stops automatically.
2. Remove the disc or turn off the power.
3. Load the disc (and press the ► PLAY button), or turn on the power. "Last Memo Play?" screen appears.

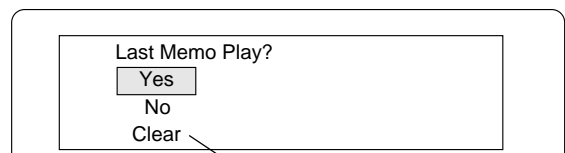

(The memory is released.)

4. Press the ▲ button to select "Yes".
5. Press the ENT button. Play resumes from the point where you stopped. (If desired, press the LAST MEMO button again.)

Note:

- Points on up to 3 discs can be memorized.
- The Last Memory Play mode may not work correctly with some discs.

What is "PBC"?

"PBC" is an abbreviation for "Playback Control" that refers to control codes prerecorded on Video CDs.

During playback of Video CD with PBC, "PbC" appears on the display.

To lock the disc tray (Main unit only)

You can lock the disc tray to prevent misuse by young children.

While the disc tray is opened, press the ▲ button until "LOC" appears on the display. (The disc tray closes.)

- The ▲ (or OPEN/CLOSE on the remote control) button will not function.

To release this mode, press the ▲ button until "Un-LOC" appears on the display.

VARIOUS PLAYING FUNCTIONS

“⊘” may appear on the TV screen during operation. This icon means that the function is not available on the disc now.

Selecting a DVD menu [DVD]

1. Press the MENU button. The main menu screen appears.
Note:
Press the MENU button again to resume play.
2. Press the ▲, ▼, ◀ or ▶ button (or the number buttons) to select the desired menu, then press the ENT button. The selected menu play starts.

Selecting a top menu [DVD]

1. Press the TOP MENU button. The top menu appears.
2. Press the ▲, ▼, ◀ or ▶ button (or the number buttons) to select the desired menu, then press the ENT button. The selected menu play starts.

Note:

Selecting a menu operation may differ depending on the disc used and may not be possible on some discs.

Return button (RETURN) for VCD

Normally, it returns to the previous menu when the RETURN button is pressed during play.

Note:

The operation differs according to the content of the VCD.

Chapter (Track) skip

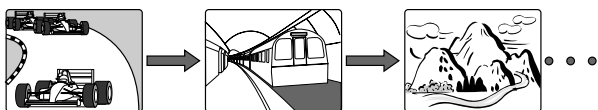

Skipping forward

Press the NEXT ►► button during play to skip to the next chapter (or track). A chapter (or track) is skipped each time the button is pressed.
- When using the main unit, use the ►► button.

Skipping backward

Press the PREV ◀◀ button during play to skip back to the beginning of the chapter (or track) currently play. Press the button again immediately to skip back to the beginning of the previous chapter (or track).
- When using the main unit, use the ◀◀ button.

Note:

You can skip only through the chapters, not over the title on the DVD disc.

Title search [DVD]

1. Press the SEARCH MODE button once during play or in the stop mode. The title search screen appears.
Example:

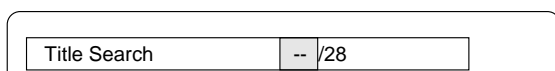

2. Press the number buttons to enter the title number.
Example:
To select No. 3, press 0, then 3 (or press 3).
To select No. 10, press 1, then 0.
To select No. 24, press 2, then 4.
- If you make a mistake, press the CLEAR button.
3. Press the ► PLAY button. Play starts from the selected title.

Chapter search [DVD]

1. Press the SEARCH MODE button twice during play. The chapter search screen appears.
Example:

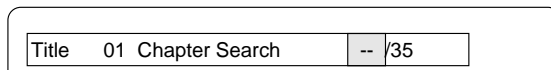

2. Press the number buttons to enter the chapter number.
3. Press the ► PLAY button. Play starts from the selected chapter.

Track search [VCD] [CD]

Press the number buttons during play or in the stop mode, then press the ► PLAY button. Play starts from the selected track.

Time search

[DVD]

1. Press the SEARCH MODE button three times during play. The time search screen appears.
Example:

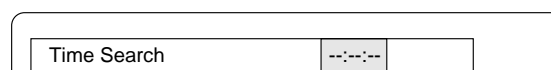

2. Press the number buttons to enter the time.
Example:
20 minutes 5 seconds Press 2, 0, 0 then 5.
1 hour 4 minutes 35 seconds Press 1, 0, 4, 3 then 5.
- If you make a mistake, press the CLEAR button.
3. Press the ► PLAY button. Play starts from the searched time.

[VCD] [CD]

1. Press the SEARCH MODE button once during play. The time search screen appears.
2. Press the number buttons to enter the time.
3. Press the ► PLAY button. Play starts from the searched time in the track.

Fast play

Press the ►► FWD or ◀◀ REV button repeatedly to select the fast speed forward or reverse play (up to 200 times normal speed in DVD).

[DVD] [VCD]

“►► 1”, “►► 2”, “►► 3”, “►► 4” or “◀◀ 1”, “◀◀ 2”, “◀◀ 3”, “◀◀ 4”

[CD]

“►► 1”, “►► 2” or “◀◀ 1”, “◀◀ 2”

Press the ► PLAY button to return to normal play.

Slow-motion play

[DVD]: Forward/Reverse slow play, [VCD]: Forward slow play only

Press the FWD SLOW ►| or REV SLOW ◀| button repeatedly to select the forward or reverse slow speed play.

“►| 1”, “►| 2”, “►| 3”, “►| 4” or “◀| 1”, “◀| 2”, “◀| 3”, “◀| 4”

Press the ► PLAY button to return to normal play.

Note:

The sound is muted during fast play or slow-motion play in DVD/VCD.

Still picture (Pause)

[DVD] [VCD]: Still picture mode, [CD]: Pause mode

Press the || PAUSE/STEP button during play.

Press the ► PLAY button to return to normal play.

Note: The sound is muted.

Frame by frame advance play [DVD] [VCD]

Press the **II PAUSE/STEP** button during still play. Each time the button is pressed, the picture advances one frame.

Press the **▶ PLAY** button to return to normal play.

Note:

- The sound is muted.
- Frame play is operative in forward mode only.

Picture zoom (Pin point zoom) [DVD]

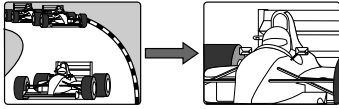

1. Press the **ZOOM** button during normal, slow or still play. The pin point guide screen appears.

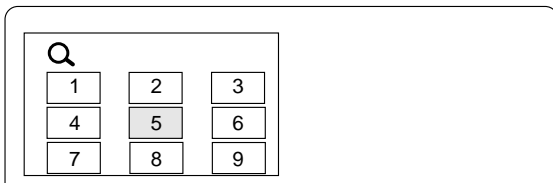

- If you quit the screen, press the **ZOOM** button.
2. Press the **▲**, **▶**, **▼** or **◀** button, then the **ENT**, or press the number button to select the zoom point. The screen is magnified. "Q 1" appears briefly on the screen. If necessary, press the **▲**, **▶**, **▼** or **◀** button repeatedly to move the screen.
 3. Press the **ZOOM** button again. The screen is magnified more than "Q 1". "Q 2" appears briefly.
 4. Press the **ZOOM** button to return to the original screen.

Note:

Picture zoom may not work on some discs.

Viewing from a desired camera angle (Multi-Angle) [DVD]

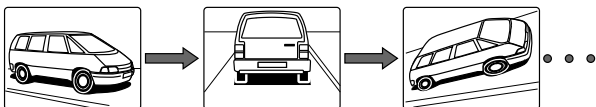

Some DVD discs may contain scenes which have been shot simultaneously from a number of different camera angles. The jacket or case of discs that are recorded with angles will be marked.

Example:



Note: The recorded angles differ depending on the disc used.

1. Play the disc that is recorded with angles.
2. Press the **ANGLE** button repeatedly until the desired angle appears.

Example:



Angle replay [DVD]

During Multi-angle play screen, press the **ANGLE REPLAY** button. The unit skips back to last approximately 10 seconds, changes it to the next camera angle and plays it, and continues play. (If desired, press the button again.)

Repeat play

Press the **REPEAT** button during play (or programmed play) of the title (or track) you want to repeat. Each time the button is pressed, the repeat mode changes as follows.

TV screen	Display	Operation
[DVD]		
	Chapter	REP 1
	Title	ALL REP
	Off	Repeat of chapter being played
[VCD] [CD]		
	1	REP 1
	All	ALL REP
	Off	Repeat of track being played
During programmed play [VCD] [CD]		
	Program 1	REP 1
	Program All	ALL REP
	Off	Repeat all tracks
		Repeat off mode

Designated range repeat play (A-B Repeat)



1. Press the **A-B REPEAT** button during play at the beginning of the section you want to repeat (Point A). "A-" appears on the screen. "A-" appears on the display.
2. Press the **A-B REPEAT** button again at the end of the section (Point B). "A-B" remains lit on the display. The section between points A and B is played repeatedly.
3. To return to normal play, press the **A-B REPEAT** button again.

Note:

Repeat play or A-B repeat play mode may not work correctly with some discs.

Notes on using Video CD with PBC

To use the repeat play or A-B repeat play mode, select PBC off play mode as follows.

In the stop mode, press the number button(s) to select the track number then press the **▶ PLAY** button.

Random play [CD]

1. Press the **PROGRAM/RANDOM** button once in the stop mode. "Random" appears on the screen.
2. Press the **▶ PLAY** button to begin random play. "RND" appears on the display. The unit will automatically select tracks at random.

Note:

The **A-B REPEAT** and **SEARCH MODE** buttons do not work during random play.

Programmed play [VCD] [CD]

Up to 20 selections can be programmed.

Programming procedure

1. Press the PROGRAM/RANDOM button once (VCD) or twice (CD) in the stop mode. The programme mode screen appears.

2. Press the number buttons to select the track number.

Example:

To select track No.3, press 0, then 3.

To select track No.10, press 1, then 0.

To select track No.24, press 2, then 4.

- If you make a mistake, press the CLEAR button.

3. Press the ▼ button to move the highlighted box down.

Example:

Program Mode					
All Clear					
1	03	6	--	11	--
2	--	7	--	12	--
3	--	8	--	13	--
4	--	9	--	14	--
5	--	10	--	15	--
				16	--
				17	--
				18	--
				19	--
				20	--

4. Repeat step 2 - 3 above to select another track.

5. Press the ► PLAY button to start play. "PGM" appears on the display. When all programmed selections have played, the unit stops automatically.

- The programme contents are retained in memory.

Note:

To play the programme again, press the PROGRAM/RANDOM button once (VCD) or twice (CD) to call up the programme mode screen, then press the ► PLAY button.

To clear the programme one by one

In the programme mode, press the ▲ or ▼ button to select the track number. Then press the CLEAR button.

To clear all the programmes

In the programme mode, press the ▲ button to select "All Clear". Then press the ENT button.

To change the programme

1. In the programme mode, press the ▲ or ▼ button to select the track number.

2. Press the number buttons to select the track number to be replaced.

Press the PROGRAM/RANDOM button to quit the programme mode screen.

Selecting subtitle language [DVD]

This operation works only with discs on which multiple subtitle languages are recorded.

1. Press the SUBTITLE ON/OFF button during play. The subtitle language mark appears on the screen (Example: 1/3 en). If "Off" appears, press the button again.

2. Press the SUBTITLE CHANGE button repeatedly until the desired subtitle language appears on the screen.

Example:



After few seconds, "Off" disappears.

Note:

- In some cases, the subtitle language is not changed to the selected one.
- When a disc supporting closed caption is played, the subtitle and the closed caption may overlap each other on the TV screen. In this case, turn the subtitle off.
- When the desired language is not selected even if the button is pressed, the language is not available on the disc.
- When the power is turned on or the disc is replaced, select the subtitle language again.
- If the subtitle language is not necessary, press the SUBTITLE ON/OFF button to select "Off".

Selecting audio soundtrack language (Multi-Language) [DVD]



This operation works only with discs on which multiple audio soundtrack languages are recorded.

1. Press the AUDIO button during play.
2. Press the AUDIO button repeatedly until the desired language appears on the screen.

Example:

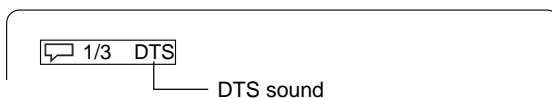

- If using an amplifier with DTS decoder, the DTS sound will be heard.

Note:

- When the desired language is not selected even if the button is pressed, the language is not available on the disc.
- When the power is turned on or the disc is replaced, select the language again.
- If the language is not recorded on the disc, only the available language on the disc will be heard.

Changing the audio channel output [VCD]

During VCD play, press the AUDIO button to select an audio channel.

Left Mono (L) → Right Mono (R) → Stereo → ...

Note: You cannot change an audio channel from the optical DIGITAL OUT socket.

Selecting on-screen information

Press the ON SCREEN button repeatedly to show the disc information (Title, Chapter, Title elapsed playing time, Language, etc.).

Example for DVD:

1. Press the ON SCREEN button during play.

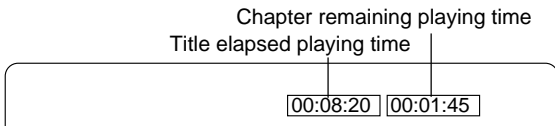

2. Press the ON SCREEN button again.

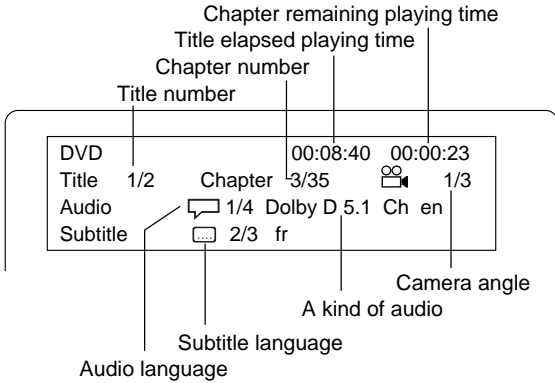

3. Press the ON SCREEN button again to close the disc information.

Example for VCD:

1. Press the ON SCREEN button during play.

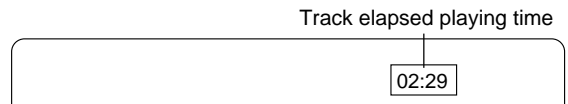

2. Press the ON SCREEN button again.

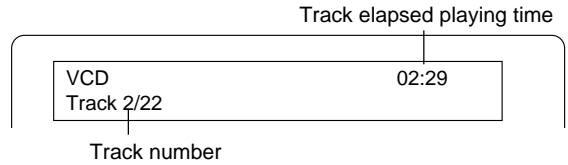

3. Press the ON SCREEN button again to close the disc information.

Note:

For Audio CD, please refer to "Example for VCD" as above.

Selecting picture mode

Press the PICTURE MODE button. Each time the button is pressed, the picture mode changes as follows:

Standard → Mild → Black and White → Standard ...

Selecting Spatializer N-2-2™ virtual surround sound mode

Press the SURROUND button to set the Spatializer N-2-2 virtual surround sound. "3D" appears on the display.

Press the button again to return to the original mode. "3D" disappears.

Portions of this product are licensed from Desper Products, Inc., a subsidiary of Spatializer Audio Laboratories, Inc. Copyright ©1997-2003 Spatializer Audio Laboratories, Inc. All Rights Reserved Worldwide. *Spatializer*®, N-2-2™ and the circle-in-square device are trademarks of Desper Products, Inc.

MP3/WMA CD OPERATION

Before starting

This unit can play back the CD that has recorded music data, MP3 or WMA (Windows Media Audio) files.

- The file system is ISO9660 level 1 and level 2.
- If the CD has both audio CD tracks and MP3/WMA files, only audio CD tracks are played.
- It would take 30 seconds or more for this unit to read MP3/WMA files depending on its structure.
- This unit can recognize up to 256 files or folders per disc. The CD with 257 files or folders and over is not available to this unit.
- MP3/WMA CDs may not be played in the recorded order.
 1. Please use the MP3 or WMA software with the function that can record data alphabetically or numerically.
 2. Please refrain from making many sub-folders by preference.

However, some CD-R/RWs and MP3/WMA CDs cannot be played back depending on the recording conditions.

Before playing back MP3 or WMA files, please read the following.

MP3 CD

- MP3 files must have the extension letters, ".MP3" or ".mp3".
- Standard, sampling frequency, and the bit rate:
MPEG-1 Audio
32kHz, 44.1kHz, 48kHz
32kbps ~ 320kbps (constant bit rate or variable bit rate)
- The recommend recording setting for a high-quality sound is 44.1kHz of sampling frequency and 128kbps of constant bit rate.

WMA CD

- When creating a WMA disc, be sure the copyright function is off. DRM files cannot be played back.
- WMA files must have the extension letters, ".WMA" or ".wma".
- Standard, sampling frequency, and the bit rate:
WMA version 7, and 8
32kHz, 48kbps ~ 64kbps
44.1kHz, 48kbps ~ 192kbps
48kHz, 128kbps ~ 192kbps

Microsoft, Windows Media, and Windows Logo are trademarks or registered trademarks of Microsoft Corporation in both the United States and other countries.

Limitations on display

- Available letters for display are the following: capital or small alphabets of A through Z, and numbers of 0 through 9.
- Other letters than those above are replaced in "-" (hyphen).

Note:

The CD has no music data or non-MP3/WMA files cannot be played back.

MP3/WMA CD play

1. Load the MP3/WMA CD.
"FILE" appears on the display and a table of contents in the first directory appears on the screen.

Example:

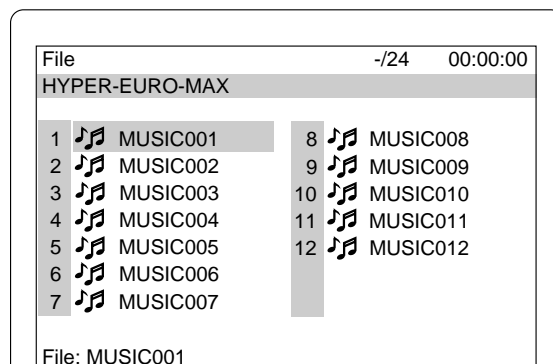

File information

2. Press the ▲, ▶, ▼ or ◀ button to move the highlighted box to the desired file.
 - To go on to the next or previous directory, press the ▲, ▶, ▼ or ◀ button.
 - To go back to the previous directory, press the RETURN button.
 - In some discs, if the MENU button is pressed, it goes back to the first directory.
3. Press the ENT or ▶ PLAY button to start play.
The letter's colour in the highlighted box turns green. "MP3" or "WMA" appears on the display.
Example: (the second directory)

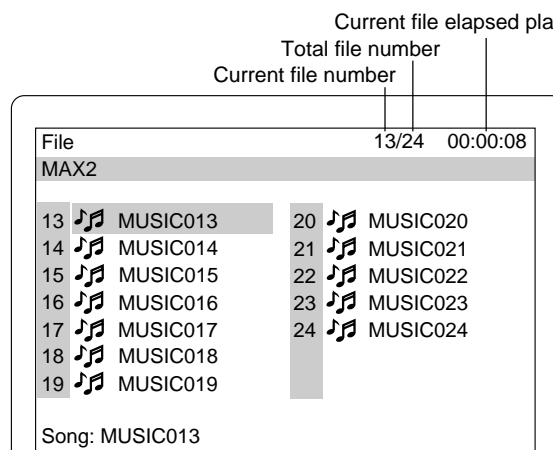

To stop play, press the ■ button.

If the disc is mixed with MP3, WMA and JPEG files...

- If you start from the MP3 or WMA file, the unit plays both MP3 and WMA files. But the unit skips the JPEG files automatically.
- If you start from the JPEG file, the unit plays the JPEG files. But the unit skips both MP3 and WMA files automatically.

PICTURE CD OPERATION

You can view digital images from KODAK Picture/JPEG files.

- The file system is ISO9660 level 1 and level 2.
- If the CD has both audio CD tracks and JPEG files, only audio CD tracks are played.
- It would take 30 seconds or more for this unit to read JPEG files depending on its structure.
- This unit can recognize up to 256 files or folders per disc. The CD with 257 files or folders and over is not available to this unit.
- JPEG CDs may not be played in the recorded order.
- JPEG files must have the extension letters, ".JPG" or ".jpg".
- JPEG resolution up to 5760 x 3840.

KODAK Picture CD play

With KODAK Picture CD, it is easy to turn film into pictures you can email from your PC and view on the unit.

Just bring your film in for processing, and check the box for KODAK Picture CD. You will get back your prints and negatives as usual - plus you will get a special CD that contains your pictures along with software that lets you view, enhance, share, and print your pictures from your PC and view them on the unit.

1. Load the KODAK Picture CD.
"PHOTO" appears on the display and the first thumbnail pictures (maximum 9-picture) appear on the screen.
Example:

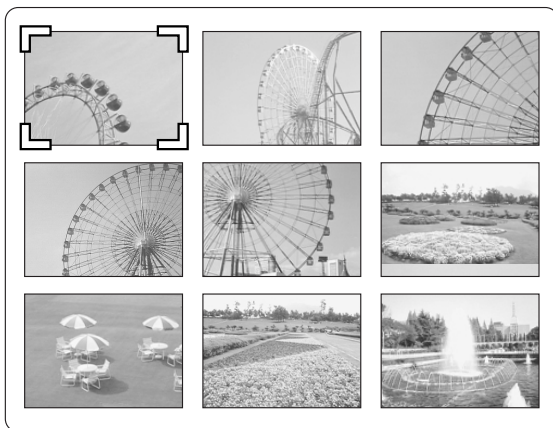

2. Press the ▲, ►, ▼ or ◀ button to move the cursor to the desired picture.
 - To go to the next or previous thumbnail pictures, press the NEXT ►► or PREV ◀◀ button.
3. Press the ENT or ► PLAY button to start the slide show from the selected picture.

Press the || PAUSE/STEP button during the slide show to pause. Press the ► PLAY (or || PAUSE/STEP) button to continue.

If the picture appears upside down or sideways,

- 1) Press the || PAUSE/STEP button, if necessary.
- 2) Press the ANGLE button repeatedly until it's right side up. "↶90°", "↷180°", "↷270°" or "Normal" appears briefly on the screen.
- 3) Press the ► PLAY (or || PAUSE/STEP) button to skip to the next picture and continue the slide show.

If you press the NEXT ►► or PREV ◀◀ button during the slide show, it skips to the next picture or previous picture.

After the last picture has displayed, the last thumbnail pictures appear.

- To stop the slide show, press the ■ button. The thumbnail pictures appear.
- If the TOP MENU button is pressed during the slide show, the thumbnail pictures appear.

If you press the MENU button, the file list appears.

Example:

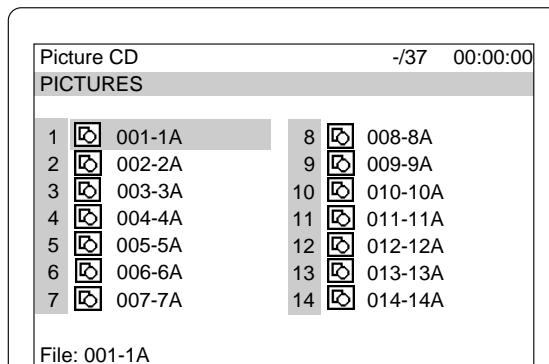

To start the slide show from the file list:

1. Press the ▲, ►, ▼ or ◀ button to select the desired file.
2. Press the ENT or ► PLAY button to start the slide show.

The file list appears after the last picture has displayed.

Note:

- FUJICOLOR CD can be used.
- Some discs cannot be played back depending on the recording conditions.

KODAK and Picture CD are registered trademarks of Eastman Kodak Company.

JPEG CD play

You can also view digital images from JPEG files on disc created by your PC.

- Some JPEG files cannot be played back depending on the recording conditions.

1. Load the JPEG CD.
"FILE" appears on the display and the file list appears on the screen.
Example:

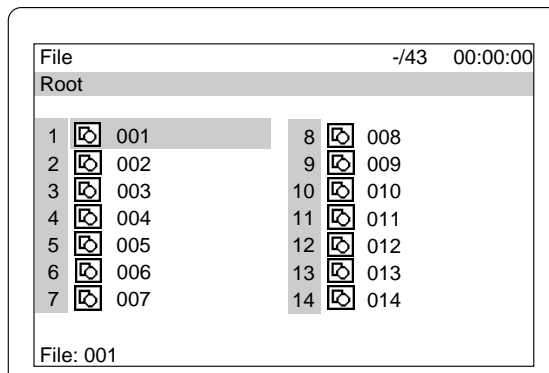

2. Press the ▲, ►, ▼ or ◀ button to select the desired file.
3. Press the ENT or ► PLAY button to start the slide show from the selected file. "PHOTO" appears on the display.

The file list appears after the last file has displayed.

- To stop the slide show, press the ■ button. The file list appears.

Picture zoom

1. Press the || PAUSE/STEP button at the desired picture (KODAK Picture CD and JPEG CD).
2. Press the ZOOM button.
3. Press the ▲, ►, ▼ or ◀ button, then the ENT, or press the number button. The picture is magnified.
4. Press the ► PLAY button to resume the slide show.

INITIAL SETTINGS FOR DVD

Once the initial settings have been completed, the unit can always be operated under the same conditions. The settings will be retained in the memory until they are changed, even if the power is turned off.

Setting language

1. Press the SETUP button in the stop mode. The setup screen appears and "Language" is highlighted.

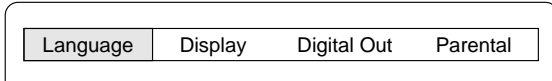

2. Press the ENT button. "Language" screen appears.
3. Press the ▼ or ▲ button to select the item (highlighted). Example: To set "OSD" (On screen display)

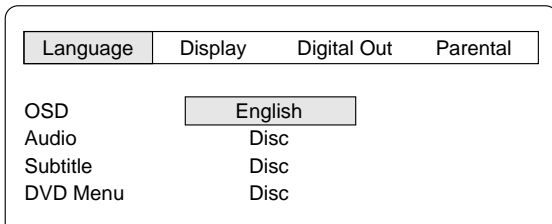

"OSD" setting is applied also to VCD and CD.

4. Press the ENT button. The submenu appears. Example:

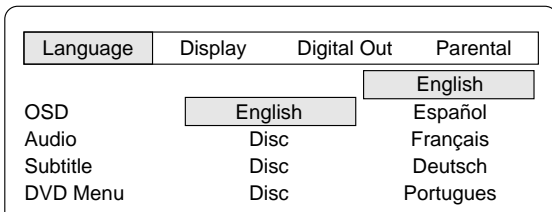

5. Press the ▼ or ▲ button to select the language (highlighted).
 6. Press the ENT button. The selected language remains.
 7. Repeat steps 3 - 6 for other items.
- Note:
If "Others" is selected, enter the language code. (See "LANGUAGE CODE LIST" on page 15.)
8. Press the ▲ button to skip back to the setup screen (or press the SETUP button to quit the setup screen).

Note:

- You cannot switch audio sound track languages if there is only one language recorded on the disc.
- When you play a DVD disc, the unit automatically displays the pre-selected subtitle language if it is included on the disc.

For improvement, on-screen displays subject to change without notice.

Setting display

1. Press the SETUP button in the stop mode. The setup screen appears.

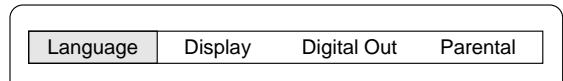

2. Press the ► button to select "Display", then press the ENT button. "Display" screen appears.

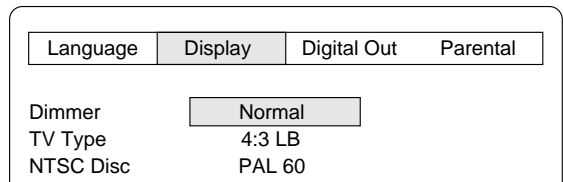

3. Press the ▼ or ▲ button to select the item (highlighted), then press the ENT button. The submenu appears. Example: To set "Dimmer"

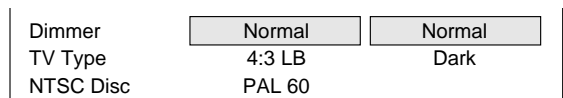

4. Press the ▼ or ▲ button to select the submenu (highlighted). Example: To select "Dimmer: Dark"

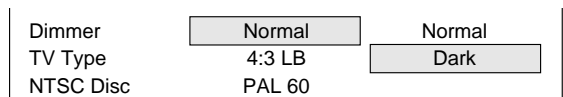

5. Press the ENT button. (In this example, "Dimmer: Dark" remains.)
6. Repeat steps 3 - 5 for other items.
7. Press the ▲ button to skip back to the setup screen (or press the SETUP button).

Dimmer:

Select the display brightness ("Normal" or "Dark").

TV Type:

Select the appropriate setting for your TV screen size.

4:3 LB (Letterbox):

Select when a conventional TV set is connected. When the wide screen disc is played, the black bands appear at the top and bottom of screen.

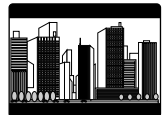

4:3 PS (Panscan):

Select when a conventional TV set is connected. When the wide screen disc is played, it displays pictures cropped to fill your TV screen. The left and right edges are cut off.

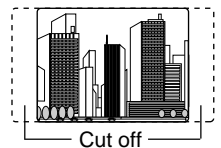

16:9 :

Select when a wide screen TV set is connected. Played in "FULL" size. (Setting the wide screen TV to "FULL" mode is also necessary.)



Note:

- The screen size may differ depending on the DVD discs.
- If you select "16:9" to get rid of the black bands on screen when wide screen disc is played, picture may be slightly distorted.
- In some discs, even if "4:3 PS" is selected, the black bands may remain on the screen.

NTSC Disc:

Select the video output signal format to "PAL 60" or "NTSC" when playing back the NTSC discs.

Setting digital out

If the optical DIGITAL OUT socket is connected to the amplifier, you must set as follows:

1. Press the SETUP button in the stop mode. The setup screen appears.

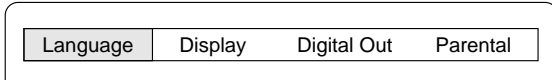

2. Press the ► button to select "Digital Out", then press the ENT button. "Digital Out" screen appears.

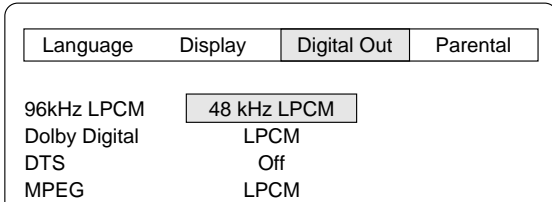

3. Press the ▼ or ▲ button to select the item (highlighted), then press the ENT button. The submenu appears.

Example: To set "Dolby Digital"

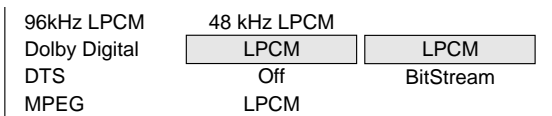

"MPEG" setting is applied also to VCD.

4. Press the ▼ or ▲ button to select the submenu (highlighted). Example: To select "Dolby Digital: BitStream"

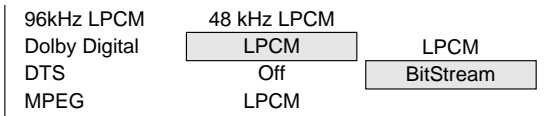

5. Press the ENT button. (In this example, "Dolby Digital: BitStream" remains.)
6. Repeat steps 3 - 5 for other items.
7. Press the ▲ button to skip back to the setup screen (or press the SETUP button).

96kHz LPCM (96kHz Liner Pulse Code Modulation):

If your amplifier is available for 96kHz sampling, select "96kHz LPCM". If not, select "48kHz LPCM".

Note:

- When "48kHz LPCM" is set, there are 48kHz LPCM audio signals from the AUDIO OUT sockets, not 96kHz LPCM audio signals.
- When playing back the DVD disc which recorded with 96kHz LPCM, there is no digital output.
- But playing back the DVD disc with no copyright protection, the sound is original recorded sound.

Dolby Digital:

If your amplifier has Dolby Digital decoder, select "BitStream". If not, select "LPCM".

DTS:

If your amplifier has DTS decoder, select "On". If not, select "Off".

MPEG (Moving Picture Expert Group):

If your amplifier has MPEG-2 decoder, select "BitStream". If not, select "LPCM".

Setting parental

1. Press the SETUP button in the stop mode. The setup screen appears.

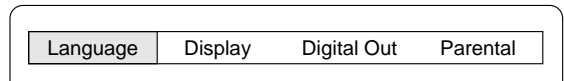

2. Press the ► button to select "Parental", then press the ENT button. "Parental" screen appears.

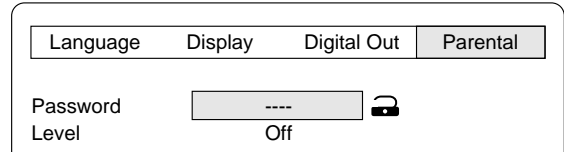

3. Press the ▼ button to skip "Password: ----" and select "Level".

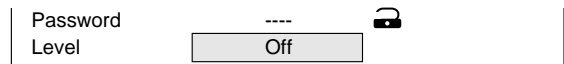

4. Press the ENT button repeatedly to select the parental lock level ("Level: Off, 1 ~ 8").

Example: To set "Level 1"

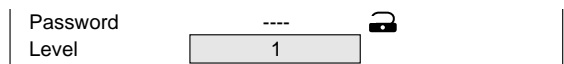

5. Press the ▲ button to return to "Password: ----".
6. Enter a number in 4 digits.

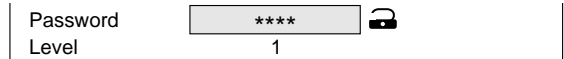

Note:

If you make a mistake, press the CLEAR button.

7. Press the ENT button. The password is now set.

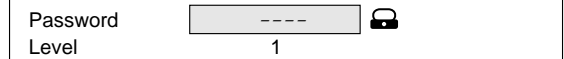

Note:

If you do not set it, Parental control does not work, and it returns to the initial settings.

8. Press the SETUP button. The setup screen disappears.

Parental control

MPAA (Motion Picture Association of America) guideline is a rating system that provides advanced cautionary information to parents about the content of movie programmes.

The parental lock level is equivalent to the following MPAA rating system.

Level 7: NC-17 (No one 17 and under admitted)

Level 6: R (Restricted)

Level 4: PG-13 (Parents strongly cautioned)

Level 3: PG (Parental guidance suggested)

Level 1: G (General audiences)

Some DVD discs contain a restriction level which enables parents to prevent playback of discs by children. This unit is equipped with a password designed to prevent children changing the level.

You cannot play DVD discs rated higher than the level you selected unless you cancel the parental lock function.

For example, when you select level "5", the unit will not play discs with ratings of "6", "7" or "8". The information will appear on the TV screen.

If you forget the password...

Enter "788444" even if 4 digits "----" appears, then press the ENT button to clear the current password. Enter a new password and set the parental lock level again.

Note:

DVD discs may or may not respond to the parental lock settings. Make sure this function works with your DVD discs.

LANGUAGE CODE LIST

Enter the appropriate code number for the initial settings "Audio", "Subtitle" and "DVD Menu".

Code	Abbreviation of the language	Language	Code	Abbreviation of the language	Language	Code	Abbreviation of the language	Language
6565	aa	Afar	7369	ie	Interlingue	8278	rn	Kirundi
6566	ab	Abkhazian	7375	ik	Inupiak	8279	ro	Romanian
6570	af	Afrikaans	7378	in	Indonesian	8285	ru	Russian
6577	am	Amharic	7383	is	Icelandic	8287	rw	Kinyarwanda
6582	ar	Arabic	7384	it	Italian	8365	sa	Sanskrit
6583	as	Assamese	7387	iw	Hebrew	8368	sd	Sindhi
6589	ay	Aymara	7465	ja	Japanese	8371	sg	Sangro
6590	az	Azerbaijani	7473	ji	Yiddish	8372	sh	Serbo-Croatian
6665	ba	Bashkir	7487	jw	Javanese	8373	si	Singhalese
6669	be	Byelorussian	7565	ka	Georgian	8375	sk	Slovak
6671	bg	Bulgarian	7575	kk	Kazakh	8376	sl	Slovenian
6672	bh	Bihari	7576	kl	Greenlandic	8377	sm	Samoan
6673	bi	Bislama	7577	km	Cambodian	8378	sn	Shona
6678	bn	Bengali; Bangla	7578	kn	Kannada	8379	so	Somali
6679	bo	Tibetan	7579	ko	Korean	8381	sq	Albanian
6682	br	Breton	7583	ks	Kashmiri	8382	sr	Serbian
6765	ca	Catalan	7585	ku	Kurdish	8383	ss	Siswati
6779	co	Corsican	7589	ky	Kirghiz	8384	st	Sesotho
6783	cs	Czech	7665	la	Latin	8385	su	Sundanese
6789	cy	Welsh	7678	ln	Lingala	8386	sv	Swedish
6865	da	Danish	7679	lo	Laothian	8387	sw	Swahili
6869	de	German	7684	lt	Lithuanian	8465	ta	Tamil
6890	dz	Bhutani	7686	lv	Latvian, Lettish	8469	te	Telugu
6976	el	Greek	7771	mg	Malagasy	8471	tg	Tajik
6978	en	English	7773	mi	Maori	8472	th	Thai
6979	eo	Esperanto	7775	mk	Macedonian	8473	ti	Tigrinya
6983	es	Spanish	7776	ml	Malayalam	8475	tk	Turkmen
6984	et	Estonian	7778	mn	Mongolian	8476	tl	Tagalog
6985	eu	Basque	7779	mo	Moldavian	8478	tn	Setswana
7065	fa	Persian	7782	mr	Marathi	8479	to	Tonga
7073	fi	Finnish	7783	ms	Malay	8482	tr	Turkish
7074	fj	Fiji	7784	mt	Maltese	8483	ts	Tsonga
7079	fo	Faeroese	7789	my	Burmese	8484	tt	Tatar
7082	fr	French	7865	na	Nauru	8487	tw	Twi
7089	fy	Frisian	7869	ne	Nepali	8575	uk	Ukrainian
7165	ga	Irish	7876	nl	Dutch	8582	ur	Urdu
7168	gd	Scots Gaelic	7879	no	Norwegian	8590	uz	Uzbek
7176	gl	Galician	7967	oc	Occitan	8673	vi	Vietnamese
7178	gn	Guarani	7977	om	(Afan) Oromo	8679	vo	Volapük
7185	gu	Gujarati	7982	or	Oriya	8779	wo	Wolof
7265	ha	Hausa	8065	pa	Punjabi	8872	xh	Xhosa
7273	hi	Hindi	8076	pl	Polish	8979	yo	Yoruba
7282	hr	Croatian	8083	ps	Pashto, Pushto	9072	zh	Chinese
7285	hu	Hungarian	8084	pt	Portuguese	9085	zu	Zulu
7289	hy	Armenian	8185	qu	Quechua			
7365	ia	Interlingua	8277	rm	Rhaeto-Romance			

TROUBLESHOOTING GUIDE

If you have followed the instructions and are having difficulty operation the unit, locate the SYMPTOM in the left column below. Check the corresponding POSSIBLE CAUSE and CORRECTIVE ACTION columns to locate and remedy the problem.

SYMPTOM	POSSIBLE CAUSE	CORRECTIVE ACTION
No picture.	No disc is loaded.	Load a disc.
	An unplayable disc is loaded.	Load a playable disc. (Check the disc logo, type, colour system and regional code.)
	The TV is not set to receive signal from the unit.	Select the correct input function on the TV.
	No video connection.	Connect the video lead to the appropriate socket.
No sound.	No audio connections.	Connect the audio leads to the appropriate sockets.
The playback picture is poor.	An unplayable disc is loaded.	Load a playable disc. (Check the disc logo, type, colour system and regional code.)
"⊙" appears on the TV screen.	The selected function does not operate on the disc now.	The feature or action cannot be completed at this time because: <ul style="list-style-type: none"> - The feature is not available at the moment. - The DVD software restricts it. - The DVD software does not support the feature (e.g., angles).
No start play.	No disc is loaded.	Load a disc.
	An unplayable disc is loaded.	Load a playable disc. (Check the disc logo, type, colour system and regional code.)
	The disc is loaded with the label side down.	Load the disc on the disc tray correctly.
	The disc is dirty.	Clean the disc or replace it.
	"Parental" is set.	Cancel the parental lock function or change the rating level. Reset it after play.
The operation or display is not normal.	The unit must be reset.	<ol style="list-style-type: none"> 1. Disconnect the mains lead. 2. Reconnect the mains lead. 3. Resume operation.
The remote control does not work properly.	The batteries in the remote control are weak, or installed incorrectly.	Check the battery polarity (+ or -). Replace the batteries.
	The remote control is not aimed at the remote sensor window.	Aim the remote control at the remote sensor window.

CLEANING THE UNIT

Clean the outside of the unit with a clean soft cloth moistened with lukewarm water. Do not use benzene, thinner or alcohol since they will mar the finish of the surfaces.

SPECIFICATIONS

Playback standard:

PAL or NTSC

Laser:

Semiconductor laser, wavelength: 650/790 nm

Laser output (Continuous wave max.):

1 mW (DVD), 0.5 mW (CD)

Frequency range (digital audio):

4 Hz to 44 kHz (DVD fs: 96 kHz)

Signal to noise ratio:

More than 105 dB

Harmonic distortion (digital audio):

0.003 %

Wow and flutter:

Below measurable level

Outputs:

VIDEO OUT:

1.0 Vp-p (75 Ω)

AUDIO OUT:

L: 2 V rms

R: 2 V rms

S-VIDEO OUT:

Y: 1.0 Vp-p (75 Ω)

C: 0.3 Vp-p (75 Ω) PAL, 0.286 Vp-p (75 Ω) NTSC

COMPONENT VIDEO OUT:

Y: 1.0 Vp-p (75 Ω)

Cb, Cr: 0.7 Vp-p (75 Ω)

DIGITAL OUT:

For optical lead

Power requirements:

AC 110 - 240 V, 50/60 Hz

Power consumption:

12 W

Dimensions:

360(W) x 55(H) x 250(D) mm

Weight:

1.95 kg

IMPORTANT INFORMATION

Because its products are subject to continuous improvement, SANYO reserves the right to modify product designs and specifications without notice and without incurring any obligation.

The SANYO logo consists of the word "SANYO" in a bold, sans-serif font. The letter "A" is stylized with vertical lines passing through it, and the "Y" also has vertical lines through it, creating a distinctive graphic element.