

SANYO

INSTRUCTION MANUAL

ICR-S240RM
ICR-S250RM

Digital Voice Recorder

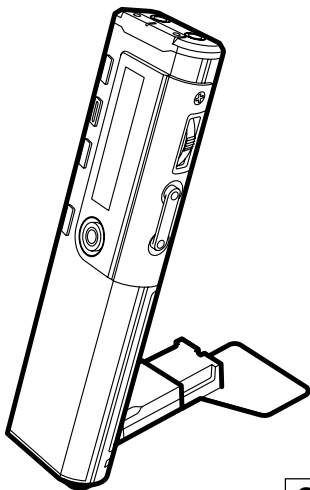

GB	English
D	Deutsch
F	Français
NL	Nederlands

Contents

Precautions	1	Erasing	15
Controls	3	Using timer	17
Before use	5	Menu setting	19
Recording	9	Connecting to PC	22
Playback	12	Troubleshooting guide	38
Selecting display	14	Cleaning the cabinet	40

Precautions

- The apparatus shall not be exposed to dripping or splashing.
- Do not remove the battery while operating the unit.
- Do not insert pins, etc., inside the unit.
- Do not drop the unit or subject it to strong shocks.
- Do not use where there are extremes of temperature (below 5°C or exceeding 35°C).
- IBM and PC/AT are registered trademarks of International Business Machines Corporation.
- Microsoft, Windows Media™, and the Windows® Logo are trademarks or registered trademarks of Microsoft Corporation in the United States and/or other countries.
- Windows Media™ Player is trademark or registered trademark of Microsoft Corporation.
- Other system and product names generally are the registered trademarks or trademarks of the respective development manufacturers. The symbols ™ and ® are not shown in this manual.
- SANYO takes no responsibility for recording failure due to power cuts or damage to the unit.
- To avoid potential risk of data loss caused by accidental operation or malfunction of the unit, we recommend that you save a backup copy of your recorded messages on a PC, etc..
- Recording copyright material without permission of the copyright owners is usually an infringement. If you wish to re-record copyright material, permission from the copyright owner is necessary. SANYO does not approve of, and cannot be held responsible for, any unlawful use of this machine.



Note:

This handling description is printed prior to product development.

When a part of the product specification must be changed to improve operability or other functions, priority is given to the product specification itself. In such instances, the instruction manual may not entirely match all the functions of the actual product.

Therefore, the actual product and packaging, as well as the name and illustration, may differ from the manual.

The screen/LCD display shown as an example in this manual may be different from the actual screen/LCD display.

Accessories

Original USB connection cable x 1

USB driver CD-ROM x 1

Headphones x 1

Battery x 1

USB cover stand x 1

Controls

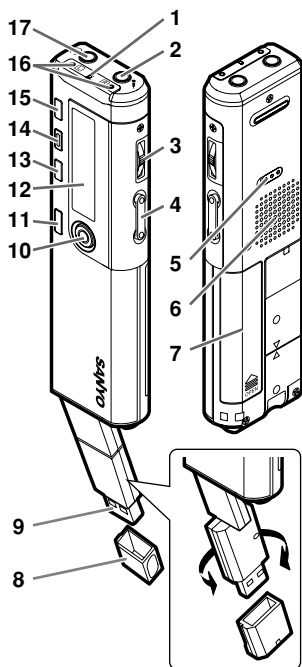

1. Recording indicator
2. External stereo microphone socket ()
3. Jog switch
(|◀◀ ▶▶| POWER ▶▶|)
(Power/Play/Speed/Skip/Search)
4. Volume buttons (VOLUME)
5. Hold switch (◀ HOLD)
6. Speaker
7. Battery compartment lid
8. USB terminal protector
9. USB terminal
10. Record button (● REC)
11. Stop/Menu button (■ STOP/MENU)
12. LCD display
13. Index button (INDEX)
14. Erase button (ERASE)
15. Folder/Repeat button (FOLDER/RPT)
16. Built-in stereo microphones (L, R)
17. Headphones socket ()

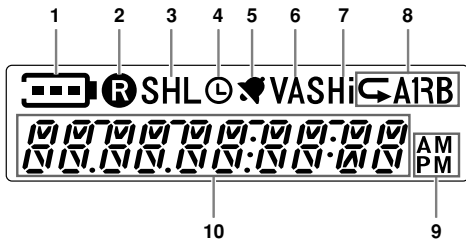

LCD display

1. Battery
2. Record
3. Recording mode
4. Timer
5. Alarm
6. VAS (Voice activated system)
7. Microphone sensitivity
8. Repeat/Random/A-B Repeat
9. AM/PM
10. Time/Message/Mode display

Before use

Inserting battery

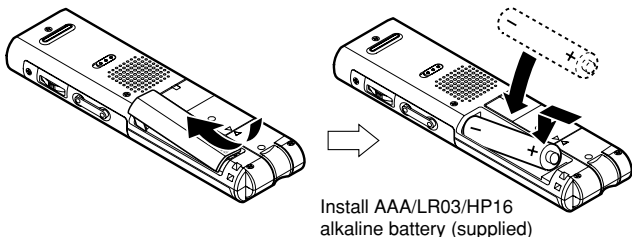

Battery indicator

Check the battery indicator on the LCD display for remaining battery power.

 : Good condition

 : Weak battery

 : Exhausted battery, must be replaced with new alkaline battery. If not, after displaying "LO BAT", the LCD display goes out.

Note:

Dispose of all used batteries safely in accordance with all applicable laws.

Note:

The date and time initialized on the LCD display will begin to blink when you perform the following: (Set the date and time. See page 8).

- Turning on the power for the first time since purchasing this product.
- Inserting a battery and turning on the power after removing a battery and leaving this product for an extended period of time.
- When the date and time settings are erased after leaving this product for an extended period of time with the battery inserted.

Using the headphones

Connect the headphones to the  socket. The speaker is automatically disconnected.

Using an external stereo microphone

Connect an external stereo microphone (not supplied) to the  socket. The built-in microphones are automatically disconnected.

Using the USB cover terminal

Be sure to install the USB cover stand when using it under the condition that this opportunity is made.

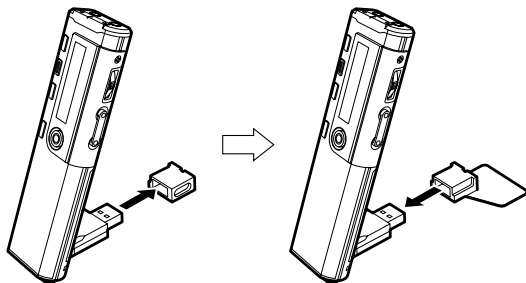

Note:

- Be sure to install the USB cover stand when using it under the condition that this opportunity is made. It becomes unstable, and fall, and sometimes causes a trouble when it is made the condition that this opportunity is made without installing the USB cover stand.
- Keep the removed USB protection cover carefully not to lose it. And, keep it in the place where a child doesn't reach it. Consult a doctor at once when swallowing it.

Turning the power on and off



Press the Jog switch. "HELLO" appears briefly on the display and the power turns on.

Then the last selected file number and total playing time appear (Resume function).

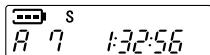

Press the Jog switch for at least 2 seconds. "byE-" appears and the power turns off.

Auto power off function

- Leaving the unit on for 15 minutes without using it automatically turns off the power.
- Leaving the unit on with recording pause for more than 15 minutes turns off the power after creating the recorded file.

Hold function

This prevents operation from stopping by accidentally pressing a button.

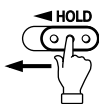

Set the ◀HOLD switch to the left. The hold function is engaged.

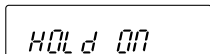

- If an operation button is pressed while the hold function is engaged, "HOLD ON" will appear and nothing else happens.

Set the ◀HOLD switch to the right. "HOLD OFF" appears and the hold function is disengaged.

To adjust the volume

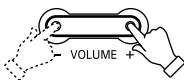

Press the VOLUME + or - button. The volume level appears (VOL 0 to VOL 20).

Selecting the beep sound (See page 21)

Selecting the menu mode (See page 21)

Selecting the backlight (See page 21)

Date and time setting

Make absolutely sure that the date and time are correctly set before starting a recording.

1. In the stop mode, press the ■ STOP/MENU button for at least 2 seconds. The first stage menu appears.

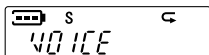

2. Move the Jog switch up or down to select "COMMON".

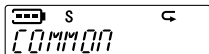

3. Press the Jog switch. The second stage menu appears.

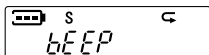

4. Move the Jog switch up or down to select "CALENDAR". The unit enters the date and time setting mode.

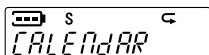

5. Press the Jog switch. The year display blinks.

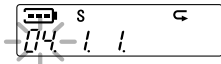

6. Move the Jog switch up or down to select the year. Then press the Jog switch. The month display blinks.

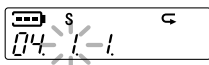

7. Set the month, day, hour display (24H or AM/PM), hour and minute by following step 6 above.

When the minute setting is completed, "CALENDAR" returns.

8. Press the ■ STOP/MENU button twice.

Recording

Recording time

The recording time differs as shown below.

ICR-S240RM

Recording mode	Recording time (approx.)
SHQ: Super high-quality	1 hr. (stereo)
HQ: High-quality	2 hr. 5 min. (stereo)
SP: Standard	4 hr. 15 min. (stereo)
LP: Long	8 hr. 35 min. (monaural)

ICR-S250RM

Recording mode	Recording time (approx.)
SHQ: Super high-quality	2 hr. 10 min. (stereo)
HQ: High-quality	4 hr. 20 min. (stereo)
SP: Standard	8 hr. 40 min. (stereo)
LP: Long	17 hr. 25 min. (monaural)

Selecting a recording mode

1. In the stop mode, press the **STOP/MENU** button for at least 2 seconds. Move the Jog switch up or down to select "VOICE", then press the Jog switch.
2. Move the Jog switch up or down to select "REC MOdE".

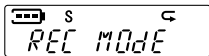
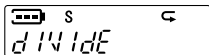

3. Press the Jog switch. The selected recording mode blinks.
4. Move the Jog switch up or down to select a recording mode.

Super high-quality

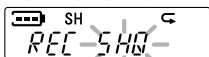

High-quality

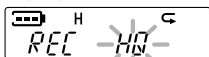

Standard

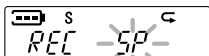

Long

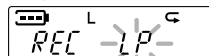

Then press the Jog switch. "REC MOdE" returns.

5. Press the **STOP/MENU** button twice.

Starting recording

1.  Press the FOLDER/RPT button to select a folder (A, b, C or d).

FOLDER/RPT



2. **REC** Press the ● REC button. Recording starts.

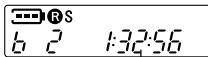

File number

Remaining recording time

To stop recording

Press the ■ STOP/MENU button.

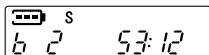

To pause recording

Press the ● REC button. Press it again to resume recording.

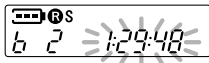

Note:

- Since the M folder is the music folder, ordinary voice data cannot be recorded to it, and is instead recorded automatically to the A folder. No recording is possible if the A folder is full.
- The unit can record up to 99 files in one folder. "FILE FULL" appears when attempting to record the 100th file.

To set index mark



INDEX

If the INDEX button is pressed during recording, an index mark is made ("INDEX 1" appears briefly) and recording continues.

- Up to 32 index marks for each file can be made. If you try to enter more index marks, "INDEX FULL" appears. Index marks cannot be deleted individually.

VAS recording

VAS: Voice activated system

1. In the stop mode, press the ■ STOP/MENU button for at least 2 seconds. Move the Jog switch up or down to select "VOICE", then press the Jog switch.

2. Move the Jog switch up or down to select "VAS".

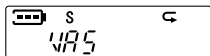

3. Press the Jog switch. The selected VAS mode appears.

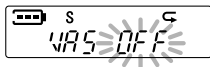

4. Move the Jog switch up or down to select "ON". Then press the Jog switch.
5. Press the ■ STOP/MENU button twice.
6. Press the ● REC button.

Recording begins when you are speaking into the microphone. When dictation stops, recording stops.

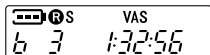

Move the Jog switch up or down to set the microphone's sensing level when recording begins. The VAS sensing level appears (VAS:1: Low - VAS:5: High).

Selecting the microphone sensitivity (See page 20)

Selecting the recording LED (See page 21)

Playback

1. Press the FOLDER/RPT button to select a folder (A, b, C, d or M).
2. Move the Jog switch up or down to select a file.

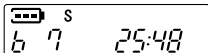

3. Press the Jog switch. Playback begins.



File number

Elapsed playing time

To stop playback

Press the ■ STOP/MENU button.

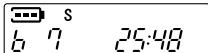

Press the Jog switch to resume playback.

Note:

- A few seconds may be required to start playback for large files or an extremely large number of files.
- Depending on the MP3/WMA file, the displayed playing time may be at variance with the actual playing time.
- Some MP3/WMA files may not be able to be played on this unit.

Changing playback speed

Press the Jog switch during playback. The playback speed changes as follows:

SLOW (Slow speed playback) → FAST (Fast speed playback) → Normal speed playback

Note:

This function may not work on some files.

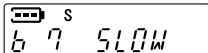

Fast forward play

Move the Jog switch up (▶▶) during playback and hold it.

This fast forwards the file currently being played. Once the end of the file has been reached, the unit will begin fast forwarding through the next file.

Fast reverse play

Move the Jog switch down (◀◀) during playback and hold it.

This fast reverses the file currently being played. Once the beginning of the file is reached, reverse continues from the end of the previous file.

- **Release the Jog switch to resume normal playback.**

To skip to the next or previous file

Move the Jog switch up (▶▶) or down (◀◀) during playback or stop.

Index search

If an index mark was made in the file, press the INDEX button during playback.

The unit will search for the next index point and playback starts from that point.

Repeat/Random playback

Only for files in the MUSIC (M) folder:

1. In the stop mode, press the ■ STOP/MENU button for at least 2 seconds. Move the Jog switch up or down to select "MUSIC", then press the Jog switch.

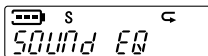

2. Move the Jog switch up or down to select "REPEAT".

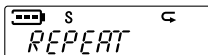

3. Press the Jog switch. The selected mode blinks.

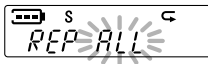

4. Move the Jog switch up or down to select the desired mode (ALL, ONE or RANd). Then press the Jog switch. "REPEAT" returns.

ALL: Repeats all files in the MUSIC (M) folder.

ONE: Repeats the current file only.

RANd: Plays all files in the MUSIC (M) folder randomly.

5. Press the ■ STOP/MENU button twice.
6. Press the Jog switch to start playback.

A-B repeat playback

1. During playback, press the FOLDER/RPT button at the beginning of the section you want to repeat (Point A).
2. Press the FOLDER/RPT button again at the end of the section you want to repeat (Point B). The specified section (between points A and B) is played back repeatedly.



Press the FOLDER/RPT button again to cancel.

Dividing a file (See page 20)

Selecting the stereo wide (See page 20)

Selecting the sound equalizer (See page 20)

Selecting the bass sound (See page 20)

Selecting display

In the stop mode, press the ■ STOP/MENU button repeatedly. The display changes as follows:

In the VOICE (A, b, C, d) folder:

Total playing time → Current date/time → Remaining recording time → Recorded date/time ("R" blinks on the display.) (if there is file)

In the MUSIC (M) folder:

Total playing time → Current date/time → Elapsed playing time (if there is file)

Erasing

Erasing the selected file

1. Press the FOLDER/RPT button to select the folder.
2. Move the Jog switch up or down to select the file to be erased.
3.  Press the ERASE button.

ERASE

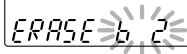

4. While the display is blinking, press the ERASE button for at least 2 seconds. The selected file is erased.

Erasing all files in the selected folder

1. Select the folder to be erased.
2. Press the ERASE button for at least 2 seconds.

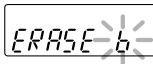

3. While the display is blinking, press the ERASE button again for at least 2 seconds. All the files in the selected folder are erased.

Note:

If you do not want to erase, press the ■ STOP/MENU button.

Note:

Only MP3/WMA files playable on this unit can be erased. Erasing files in other formats is not possible. Nothing is erased if there are no MP3/WMA files in the playable folders.

Formatting (Erasing all files in all folders)

If you select the format function from the menu, the memory will be initialized and all files will be erased. Use only when you need it. Save a backup copy of your recorded messages on a PC, etc. if required.

1. In the stop mode, press the ■ STOP/MENU button for at least 2 seconds. Move the Jog switch up or down to select "COMMON", then press the Jog switch.
2. Move the Jog switch up or down to select "FORMAT". Then press the Jog switch.
3. Move the Jog switch up or down to select "ON". Then press the Jog switch. "FORMATING", then "COMPLETE" appears and all files are erased. "FORMAT" returns.
4. Press the ■ STOP/MENU button twice.



Using timer

Alarm timer

A file can be played (or the alarm sounded) at a designated time. In the case of file playback, place the file to be played in the ALARM folder ahead of time (See page 31). The alarm will sound for 10 seconds if there are no files in the ALARM folder.

1. In the stop mode, press the ■ STOP/MENU button for at least 2 seconds. Move the Jog switch up or down to select "COMMON", then press the Jog switch.
2. Move the Jog switch up or down to select "TIMER". Then press the Jog switch.

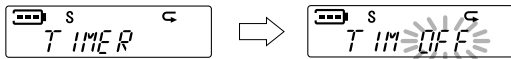

3. Move the Jog switch up or down to select "ALM ON". Then press the Jog switch. The hour display of alarm on time blinks.

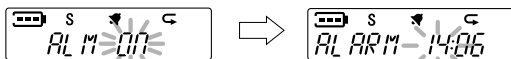

4. Move the Jog switch up or down to select the hour. Then press the Jog switch. The minute display blinks. Set the minute in the same way.

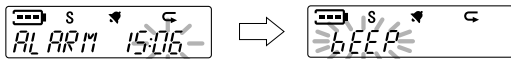

5. Move the Jog switch up or down to select the alarm sound.
bEEP: Beep sound ↔ MUSIC: File
Then press the Jog switch. "TIMER" returns.
6. Press the ■ STOP/MENU button twice.
 - If you want to cancel the alarm timer, select "TIM OFF" in the step 3 above.

When the alarm on time arrives, the alarm timer will be activated.

Timer recording

Recording can be started at a designated time. The recorded file will be created in the designated folder.

1. Follow steps 1 - 2 of "Alarm timer".
2. Move the Jog switch up or down to select "TIM ON". Then press the Jog switch. The hour display of timer on time blinks.

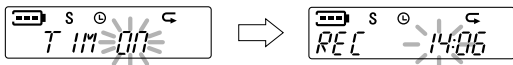

3. Move the Jog switch up or down to select the hour. Then press the Jog switch. The minute display blinks. Set the minute in the same way.

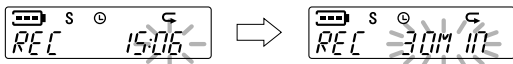

4. Move the Jog switch up or down to select the timer recording time (30MIN, 60MIN, 120MIN or ALL). Then press the Jog switch.
ALL: Recording will continue until the ■STOP/MENU button is pressed or the end of remaining recording time.

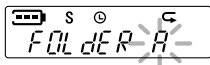

5. Move the Jog switch up or down to select the recording folder. Then press the Jog switch. "TIMER" returns.
6. Press the ■STOP/MENU button twice.
7. Turn the power off if required.
 - If you want to cancel the timer recording, select "TIM OFF" in the step 2 above.

When the timer on time arrives, recording will start.

Note:

- Make sure there is sufficient battery power when using timer recording.
- Both Alarm timer and Timer recording cannot be set at the same time.

Menu setting

Common procedures of menu setting

1. In the stop mode, press the ■ STOP/MENU button for at least 2 seconds. The first stage menu appears.
2. Move the Jog switch up or down to select the first stage menu. Each time the Jog switch is moved, the display changes as follows:

“VOICE” ↔ “MUSIC” ↔ “COMMON” ↔ “VOICE” ↔ ...

Then press the Jog switch. The second stage menu appears.

3. Move the Jog switch up or down to select the second stage menu. Each time the Jog switch is moved, the display changes as follows:

VOICE menu

“dIVIdE” ↔ “REC MOdE” ↔ “MIC MOdE” ↔ “VAS” ↔ “STEREO”
↔ “dIVIdE” ↔ ...

- “dIVIdE” cannot be selected when the MUSIC folder is selected.

MUSIC menu

“SOUNd EQ” ↔ “bASS” ↔ “REPEAT” ↔ “SOUNd EQ” ↔ ...

COMMON menu

“bEEP” ↔ “CALENdAR” ↔ “TIMER” ↔ “FORMAT” ↔ “REC LEd”
↔ “bACK LEd” ↔ “SOFT VER” ↔ “MENU MOdE” ↔ “bEEP” ↔

...

Then press the Jog switch.

4. To change the setting of the selected menu, move the Jog switch up or down. Then press the Jog switch. The second stage menu returns.
 - Press the ■ STOP/MENU button once during the menu setting. The setting is cancelled and the previous menu returns.
5. Press the ■ STOP/MENU button twice to quit the menu setting mode.

VOICE

dIvIdE: Dividing a file

You can use the file dividing function to get rid of unneeded parts or extract only those that are needed.

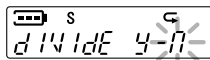

y: execute file division in this position.
N: return to menu screen.

Note:

- Short files or files in the MUSIC folder cannot be divided.
- The divided parts of files will overlap for a few seconds with files before and after.

REC MOdE: Selecting the recording mode (see page 9)

MIC MOdE: Selecting the microphone sensitivity

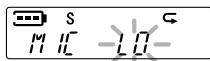

LO: Low sensitivity
HI: High sensitivity

VAS: VAS recording (see page 11)

STEREO: Selecting the stereo wide



OFF: Stereo wide off
ON: Stereo wide on

MUSIC

SOUNd EQ: Selecting the sound equalizer



OFF: Normal
PO: Pop
RO: Rock
JA: Jazz

bASS: Selecting the bass sound

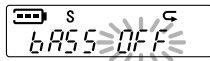

OFF: Bass off
ON: Bass on

REPEAT: Selecting the repeat mode (see page 13)

COMMON

bEEP: Selecting the beep sound

Turning on and off the beep when buttons are pressed.

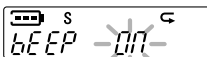

OFF: Beep off

ON: Beep on

CALENDAR: Date and time setting (see page 8)

TIMER: Using timer (see page 17)

FORMAT: Formatting (see page 16)

REC LED: Selecting the recording LED

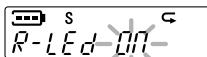

ON: Rec LED on

OFF: Rec LED off

bACK LED: Selecting the backlight

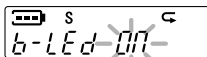

ON: Backlight on

OFF: Backlight off

SOFT VER: Checking the version number

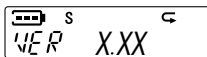

MENU MODE: Selecting the menu mode

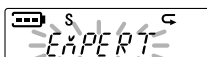

EXPERT: Displays all menu items.

SIMPLE: Displays only basic menu items (REC MODE, SOUND EQ, bASS, bEEP, CALENDAR, SOFT VER and MENU MODE).

Connecting to PC

Recommended PC environment

Supported PCs	IBM PC/AT compatible
Supported OS	Windows XP Professional Windows XP Home Edition Windows 2000 Professional Windows Millennium Edition(Me) Windows 98 Second Edition Windows 98
USB port	One required for connection
Sound board	16-bit Windows-compatible sound board supported
Other	Speakers or headphones required

Note:

- Operation is not guaranteed for Macintosh PCs.
- Operation is not guaranteed for the following environments.
 - Upgraded Windows environments
Windows 95, Windows NT
 - Dual-boot Windows environments
- Standby, suspend, and other modes may not work properly with your particular environment. If this is the case, do not use those modes.

Installing the USB driver

If you are using Windows 98/98SE, you need to install the USB driver.

- There is no need to install the USB driver, if you are using Windows XP/2000/ME.
- Reproduction of this driver is forbidden.
- This driver shall not be copied and reprinted.
- SANYO shall not be liable for any damages arising out of the use of this driver.

1. Turn on your PC and Windows is started. Do not connect the unit to the PC yet.
2. Load the USB driver CD-ROM (supplied) in the CD-ROM drive of the PC. [Stereo Digital Voice Recorder Setup] screen appears automatically.

Note:

If the screen is not displayed, right-click [Start], select [Explore].

Double click "Setup.exe" file in the CD-ROM. [Stereo Digital Voice Recorder Setup] screen appears.



3. Click [USB Driver]. [InstallShield Wizard] screen appears.

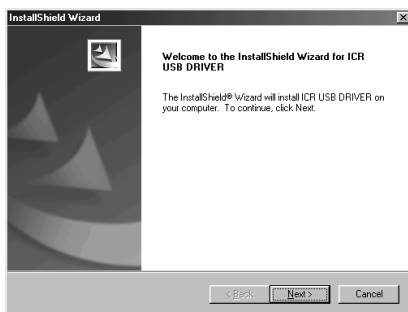

4. Click [Next].

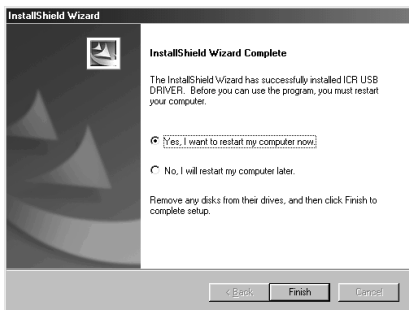

5. Check that [Yes, I want to restart ...] is selected, then click [Finish]. The PC will restart.

Connect the unit to the PC (See the next page).

The USB driver is recognized by the PC automatically and the unit is displayed as Removable Disk.

How to check whether USB driver has installed correctly or not

1. [Start] menu > [Settings] > [Control Panel] > [System] > [System Properties] > Open [Device Manager] in tab.
2. Double click [Disk drives] > double click [Hard disk controllers]. If the following screen is displayed, it means USB driver has installed correctly.

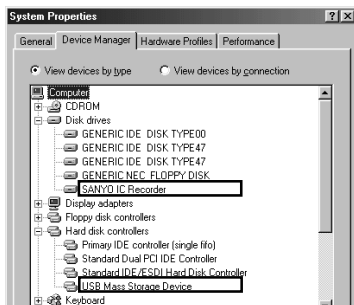

Connect the unit to your PC

The USB terminal can be connected directly to the one on your PC. Remove the USB terminal protector and connect in accordance with the direction of the terminal.

Forcing it may break the terminal. If required, use the USB connection cable (supplied).

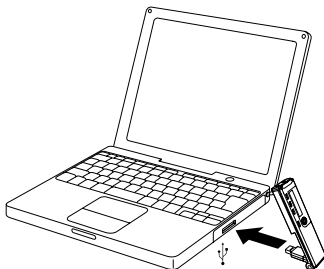

Pay attention to the direction of the terminal.

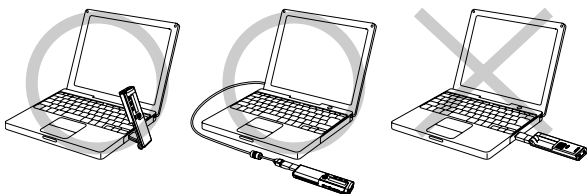

Note:

- Although the USB terminal part rotates to right and left, a stop position is in each. If it is made to rotate by force, the terminal may be damaged.
- Do not use an USB hub or USB extension cable (Operation is not guaranteed). Use only the supplied USB connection cable for connection.
- When you connect the unit to the PC for the first time, it sometimes may not be recognized as a Removable Disk. In this case, disconnect the unit and reconnect it again.
- The unit will operate without battery while the unit is connected to the PC.

Selecting the action Windows is to take

After connection, the following screen will appear (Windows XP only).

- For Windows98/98SE/ME/2000, this operation is not needed.

The screen shots are of Windows XP.

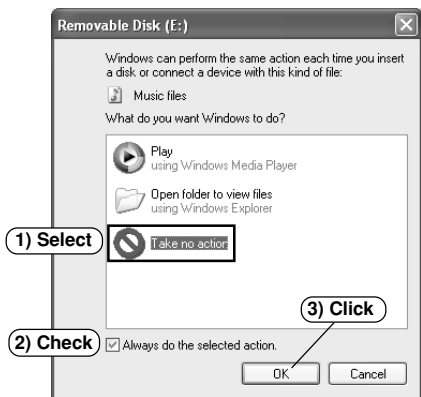

Adjust your settings to match your PC's environment.

In this manual, [Take no action] is selected, [Always do the selected action] is checked, and [OK] is clicked. This completes the connection to the PC.

When connected to the PC, the unit display will be as shown below and none of the operating buttons will work.

Connected to PC

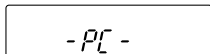

Transmitting to/from PC

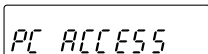

Before disconnecting the unit from the PC, be sure to follow the steps on the next page. Do not disconnect during data transfer.

Disconnecting the unit from your PC

Before disconnecting, make sure no data is being transferred.

For Windows98/98SE

Disconnect the unit from your PC.

For Windows XP/2000/ME

Follow the steps below to disconnect. (The screen shots are of Windows XP.)

- The screen might be different for a different OS.

1. Right-click the Task tray icon at the bottom right of the Windows screen.



If the icon is not displayed, refer to the Windows help.

2. Click [Safely Remove Hardware] displayed.



3. Select [USB Mass Storage Device] and click [Stop].



4. Check that [SANYO IC Recorder USB Device] is in the list, select [USB Mass Storage Device] and click [OK].



5. Disconnect the unit from your PC.

Displaying by Explorer

To start up Explorer

To use the same Explorer screen as the ones used in this manual, start up the Windows XP Explorer as follows.

- The screens displayed on your PC may not exactly correspond to those shown in this manual depending on the OS version and manufacturer.

Click [start], then right-click [My Computer], and select [Explore] from the menu that appears.



Explorer will start up.

Removable Disk display

An icon for a Removable Disk will appear in My Computer in Windows when the unit is connected to your PC.

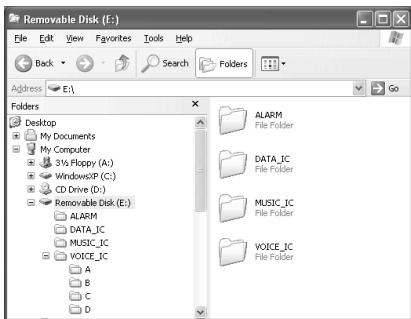

[VOICE_IC] folder

Files recorded using the unit are stored here.

- Files recorded in the internal memory A folder are stored in the A folder inside the VOICE_IC folder with the name "IC_A_XXX (file number). MP3".
- This also applies to the b, C, and d folders.
- The A, b, C, and d folders can hold up to 99 files each.
- Only those files in the VOICE_IC folder which comply with the file name rules set for folders A through d can be played.

For example, file IC_B_001.MP3 in b folder cannot be played if it is moved to A folder. Also, keep in mind that changing a file's name will prevent that file from being played on the unit.

[MUSIC_IC] folder

Files transferred from your PC are stored in this folder.

- There is no set format for file names for files which are transferred, but they must be MP3 or WMA files.
- The playback order will change if the files in MUSIC_IC folder are added. Also the same is said of the case of the directly created folder in the MUSIC_IC folder.
- You can create a folder in the MUSIC_IC folder and move files to that folder. (A folder is created directly in the MUSIC_IC folder.).

[DATA_IC] folder

This folder stores data files (Excel, Word, etc.) as a Removable Disk.

[ALARM] folder

MP3/WMA files played when the alarm sounds are stored in this folder.

- The alarm will sound if there are no files in the ALARM folder.
- Only one file can be played.

Copying data by using Explorer

Start up Explorer (See page 29).

(1) Copying files to the unit

Select the MP3/WMA files to copy and drag and drop them to the MUSIC_IC folder in the Removable Disk drive.

- Be sure to place the files in the MUSIC_IC folder in the Removable Disk. The files cannot be played if they are placed in the VOICE_IC folder.

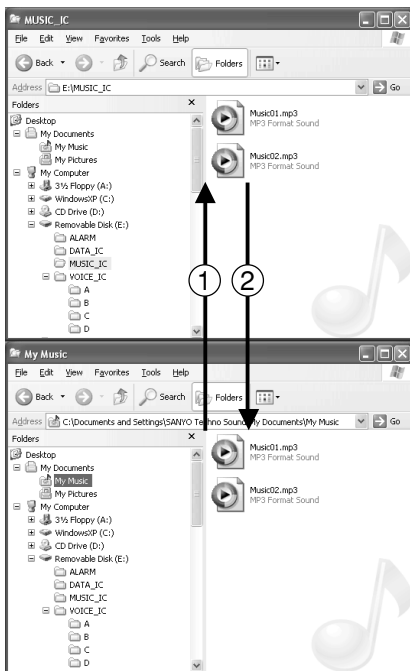

(2) Copying files to your PC

Select the MP3/WMA files you wish to copy inside the MUSIC_IC folder on the Removable Disk and drag and drop them into a folder of your choice on your PC.

Transferring data using the Media Player

If you have the Microsoft Windows Media Player installed, you can transfer WMA files to the unit and listen to them. See the Windows Media Player online help for details on how to do this.

- The screens displayed on your PC may not exactly correspond to those shown in this manual, depending on the OS version and manufacturer.
- See <http://www.microsoft.com/windows/windowsmedia/> to download the Windows Media Player.

Once it is installed, select [start] menu > [All Programs] > [Windows Media Player] to start the programme.

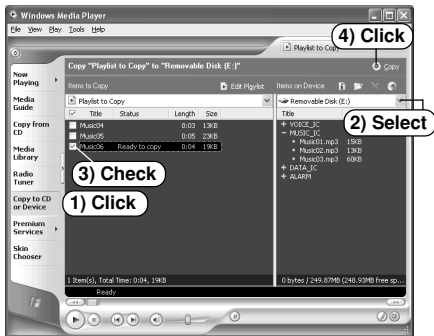

1. Click [Copy to CD or Device].
2. Select [Removable Disk] (the transfer destination) from the pull-down menu at the bottom of [Item on Device] on the right-hand side and the files will be displayed. If they do not appear, select [View] menu > [Refresh].
3. Add a checkmark to the box for the music you wish to transfer to the unit.

4. Click [Copy] button.
Transfer is complete once [Status] changes from [Copying] to [Complete].



Important note:

Never disconnect the unit from your PC during transfer.

Precaution when copying WMA files to the unit:

Transfer from your PC to the unit and/or playback are impossible in the following cases.

- Music files which are copyright protected
- Music files purchased over the Internet

Note when ripping a CD (transferring CD music files to your PC as WMA files)

Be sure to remove the copyright protection as described below before ripping a CD using Windows Media Player.

1. Start up Windows Media Player.
2. Select [Tools] > [Options].

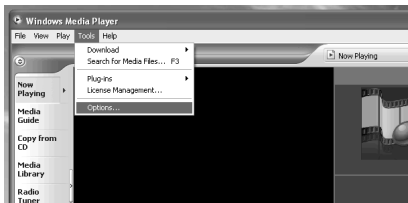

3. Open [Copy Music] in tab.
Make sure that [Copy protect music] is not checked.

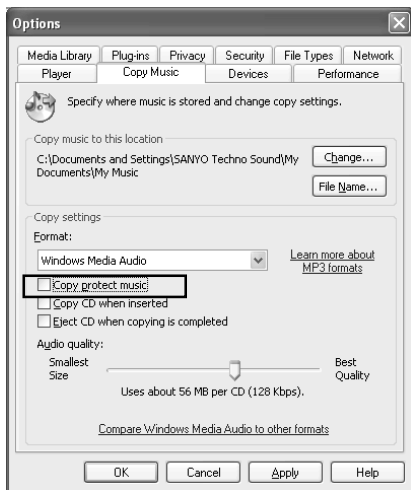

4. Click [Apply] then [OK].

Note:

- Repeatedly transferring data from your PC and/or deleting data will cause the transfer rate to slow. If this happens, turn the unit off and on.
- Some MP3/WMA files may not be able to be played on this unit.
- Any MP3 or WMA files that you transfer and that are not for your own personal enjoyment may not be used without permission from the copyright holder, as stipulated by intellectual copyright law.

Designating the playback order (Playlist)

It is possible to designate the playback order of music.

Create a playlist on your PC and transfer it to the unit to play your music in that order.

It is also possible to transfer two or more playlists to the unit.

1. Create a playlist like the one shown using a text application (like the Notepad) on your PC.
Make the name of the playlist "XXX(file name).m3u".

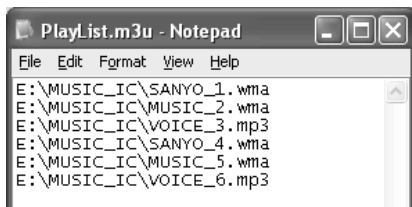

2. Using Explorer, transfer the file to the MUSIC_IC folder on the unit.
3. Disconnect the unit from your PC and start playback on the unit.
The music in the MUSIC_IC folder will be played.
 - Enter the drive and file name in the Playlist. Use only alphabets and numbers characters. (Files names must be 200 characters or shorter.)
 - The order of the voice data cannot be changed.
 - This unit is compatible with m3u files.
 - Some file formats cannot be designated for playback order.

To select the playlist:

1. Before starting playback, press the FOLDER/RPT button to select the MUSIC (M) folder.
 2. Move the Jog switch up or down to select the desired playlist. Then press the Jog switch.
 3. Press the Jog switch again to start playback with the playlist. "P" appears on the display.
- In the stop mode, press the FOLDER/RPT button to cancel the playlist playback.

Playing back music files in the created folder

When transferring files to the unit, you can create a folder in the MUSIC_IC folder and copy files to that folder.

It is possible to create two or more folders.

Note:

Folders are created directly in the MUSIC_IC folder.

To select the folder:

1. Before starting playback, press the FOLDER/RPT button to select the MUSIC (M) folder.
 2. Move the Jog switch up or down to select the desired folder. Then press the Jog switch.
 3. Press the Jog switch again to start the selected folder playback. "F" appears on the display.
- In the stop mode, press the FOLDER/RPT button to cancel the folder playback.

Formatting the unit's data

Always format data using the unit itself (See page 16).

Using your PC to do the formatting might stop the unit from recording normally.

If you accidentally formatted using your PC, reformat it using the unit.

Troubleshooting guide

Symptom

Possible cause

Corrective action

The unit does not start.

Battery is not inserted properly or is dead.

Reinsert the battery correctly or replace with new alkaline battery.

Internal memory error.

Format (initialize) the internal memory and then reattempt recording.

Buttons do not respond.

The hold function is set.

Turn off the function.

The USB connector is still connected.

Disconnect the unit from the PC.

No sound.

The volume is turned down too low.

Adjust the volume.

Files in the VOICE (A, b, C, d) folder cannot be played.

The file name is wrong.

Changing files names using your PC will render files unplayable. Return the file name to "IC_X(folder name)_XXX (file number).MP3".

Files in the MUSIC (M) folder cannot be played (correctly or at all).

The file is not in a playable format.

Use MP3/WMA-format files.

Files on the PC were not transferred to the MUSIC_IC folder.

Transfer them to the MUSIC_IC folder on the Removable Disk.

This is data which cannot be played on the unit.

Create a file using different encoder (MP3/WMA conversion) software.

You cannot play back files in the playlist, "-- : --" is displayed.

Music files you have erased remain in the PLAYLIST.m3u.

Delete music files you have erased from the PLAYLIST.m3u. (See page 36)

Symptom**Possible cause****Corrective action**

The Removable Disk is not displayed when the unit is connected to the PC.

The PC and the unit are not connected correctly.

Make sure the connect is corrected.

Disconnect the unit from the PC and reconnect it again.

Sufficient power is not being supplied from the PC.

If a USB hub is being used, reconnect the unit directly to the USB port on the PC. If the PC is equipped with several different USB ports, try another port.

The USB driver is not installed properly.

Check the installation (only for Windows98/98SE operating systems, see page 23).

A network drive has been assigned.

If a network drive has been assigned, the drive letter (the letters used as drive names) is already taken, so the Removable Disk cannot be created. Change the network drive assignments and reconnect. Talk to your network administrator about reassigning network drives.

A file can't be erased.

The attribute of the file is set up only for reading.

Please erase a file whether connects this to a PC and changes file attribute. Or please do format of built-in memory (initialization).

[FAT Err] is displayed and nothing else happens.

FAT administration system error.

Format (initialize).

Cleaning the cabinet

Clean the outside of the unit with a clean soft cloth, moistened with lukewarm water. Do not use benzene, thinner or alcohol since they will mar the finish of the surfaces.

SERVICE

UNITED KINGDOM

For online support and assistance contact:

UK: Freephone: 0800 328 7060

(Mon–Fri, 8am–5pm)

Outside of UK: +44 1582 730 730

(Mon–Fri, 8am–5pm)

Email: dictationsupport@sanyo.co.uk

or visit our website www.sanyodictation.co.uk

Specifications

Internal memory: 64MB (ICR-S240RM), 128MB (ICR-S250RM)

Frequency response (over all):

40Hz - 15kHz (Built-in microphone, SHQ)

40Hz - 7.5kHz (Built-in microphone, HQ)

40Hz - 3.5kHz (Built-in microphone, SP)

40Hz - 3.5kHz (Built-in microphone, LP)

Frequency response (playback): 20Hz - 20kHz

Music playback capability:

MP3 (16 - 44.1kHz, 16 - 192kbps)

WMA (16 - 44.1kHz, 32 - 160kbps)

Terminals: USB,  (Headphones),  (Microphone)

Output power: 10mW + 10mW

Power source: DC 1.5V ("AAA/LR03/HP16" battery x 1)

Dimensions (W x H x D): Approx. 31 x 118.5 x 14.7 mm

Weight: Approx. 57 g (including battery)

Specifications subject to change without notice.

Änderungen und Ergänzungen dieser Beschreibung / Anleitung sind vorbehalten. Für den Inhalt wird keine Haftung übernommen, insbesondere nicht für Schäden durch vorhandene, nicht vorhandene oder fehlerhafte Angaben.

Copyright by Sanyo

SANYO