

SANYO

INSTRUCTION MANUAL

MCD-Z530F

CD Portable Radio Cassette Recorder

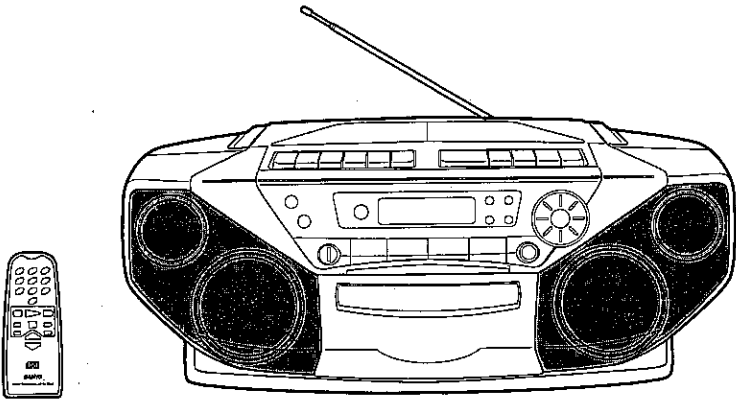

PRECAUTIONS

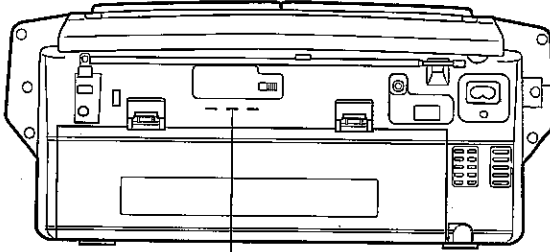

CLASS 1 LASER PRODUCT
LUOKAN 1 LASERLAITE
KLASS 1 LASERAPPARAT

CAUTION-INVISIBLE LASER RADIATION WHEN OPEN AND INTERLOCKS DEFEATED. AVOID EXPOSURE TO BEAM.

ADVARSEL-USYNLIG LASER STRÅLING VED ÅBNING, NÅR SIKKERHEDSAFBRYDERE ER UDE AF FUNKTION, UNDGÅ UDSÆTTELSE FOR STRÅLING.

VARNING-OSYNLIG LASER STRÅLNING NÅR DENNA DEL ÄR ÖPPNAD OCH SPÄRR ÄR URKOPPLAD. STRÅLEN ÄR FARLIG.

VORSICHTI -UNSICHTBARE LASERSTRAHLUNG TRITT AUS, WENN DECKEL GEÖFFNET UND ENN SICHERHEITSVERRIEGELUNG ÜBERBRÜCKT IST. NICHT, DEM STRAHL AUSSETZEN.

VARO I-Avattaessa ja suojalukitus ohitettaessa olet alttiina näkymättömälle lasersäteilylle. Älä katso säteeseen.



CAUTION - USE OF CONTROLS OR ADJUSTMENTS OR PERFORMANCE OF PROCEDURES OTHER THAN THOSE SPECIFIED HEREIN MAY RESULT IN HAZARDOUS RADIATION EXPOSURE. THE COMPACT DISC PLAYER SHOULD NOT BE ADJUSTED OR REPAIRED BY ANYONE EXCEPT PROPERLY QUALIFIED PERSONNEL.

- The apparatus shall not be exposed to dripping or splashing.
- Do not use where there are extremes of temperature (below 5 °C or exceeding 35°C).
- Because of the CD player's extremely low noise and wide dynamic range, there might be a tendency to set the volume on the amplifier unnecessarily high. Doing so may produce an excessively large output from the amplifier which could damage your speakers.
- Sudden changes in the ambient temperature may cause condensation to form on the optical lens inside the unit. If this happens, take out the disc, leave the unit for about 1 hour, and then proceed to operate.
- Do not install this equipment in a confined space, such as a book case or built in cabinet.
- The rating label is located on the bottom of the unit.

CONTROLS

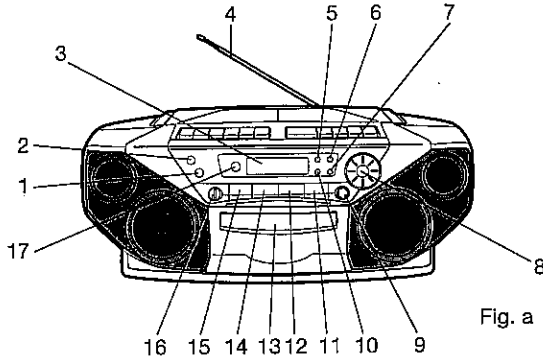

Fig. a

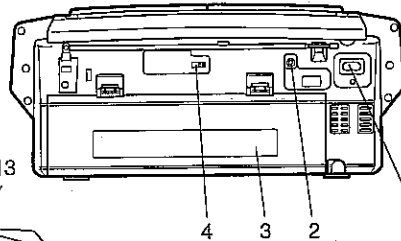

Fig. c

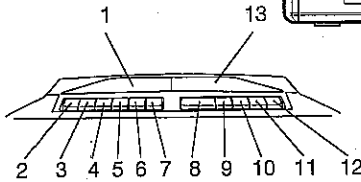

Fig. b

CD Player/Radio/General section (Fig. a)

1. Bass expander button (BASSXPANDER)
2. Q-sound button (QSOUND)
3. Display
4. Telescopic aerial
5. Radio band button (BAND)
6. Preset button (PRESET)
7. Memory button (MEMORY)
8. Volume control (VOLUME)
9. CD compartment opening button (CD OPEN)
10. Repeat/FM mode button (REPEAT/FM MODE)
11. Tuning up/Skip/Search button (TUNING UP/SKIP/SEARCH)
12. Play/Pause button (PLAY/PAUSE)
13. CD compartment
14. Stop/Clear button (STOP/CLEAR)
15. Tuning down/Skip/Search button (TUNING DOWN/SKIP/SEARCH)
16. Function switch (TAPE/CD/RADIO)
17. Remote sensor (IR)

Cassette deck section (Fig. b)

Deck B

1. Cassette holder
2. Record button (REC)
3. Play button (PLAY)
4. Rewind button (REW)
5. Fast forward button (FFWD)
6. Stop/Eject button (STOP/EJECT)
7. Pause button (PAUSE)

Deck A

8. Play button (PLAY)
9. Rewind button (REW)
10. Fast forward button (FFWD)
11. Stop/Eject button (STOP/EJECT)
12. Pause button (PAUSE)
13. Cassette holder

Rear (Fig. c)

1. AC input socket (AC INPUT)
2. Headphones socket (PHONES)
3. Battery compartment lid
4. Beat cancel switch (BEAT CANCEL)

POWER SUPPLY

AC POWER

Connect one end of the mains lead to the AC INPUT socket and the other end to an AC outlet.

Note:

- The installed batteries are automatically disconnected when the mains lead is connected to the unit
- The function (TAPE/CD/RADIO) switch is mounted on the secondary side. The unit is not disconnected from mains, even switched off.

BATTERY POWER

Installing batteries

Install eight "D/R20" batteries (not supplied) as shown below.

Cautions on batteries

To prevent battery electrolyte leakage, which may result in injury and damage to the unit or other objects, observe the following precautions:

1. All batteries must be installed with the proper polarity (see diagram on the rear of the unit).
2. Do not mix new with old or used batteries.
3. Only use batteries of the same type and brand.
4. Remove the batteries when they are not to be used for a long period time.
5. When the batteries have become discharged, they must be disposed of in a safe manner which complies with all applicable laws.

1

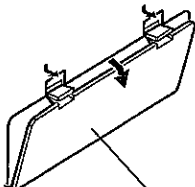

Battery compartment lid

2

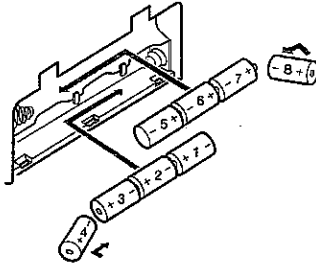

3

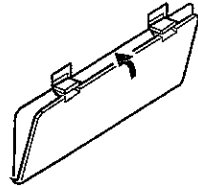

REMOTE CONTROL

Controls

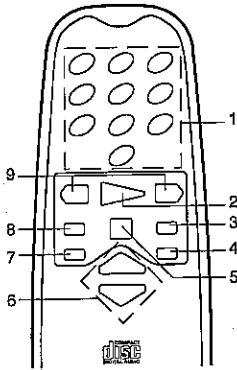

1. Number buttons (1 - 9, 0)
2. Play/ Pause button (PLAY/PAUSE)
3. Memory button (MEMORY)
4. Radio band button (BAND)
5. Stop/ Clear button (STOP)
6. Volume buttons (VOLUME)
7. Preset button (PRESET)
8. Repeat/ FM mode button (REPEAT/FM MODE)
9. Tuning/ Skip/Search buttons (TUNING +,-/SKIP/SEARCH)

Number buttons (1 - 9, 0)

If the function is "CD", the buttons select the track numbers on a disc.

If the function is "RADIO", the buttons select pre-set radio stations.

With any other function, the buttons will not function.

- Two buttons must always be pressed.

Example:

To select No. 3, press 0, then 3.

To select No.10, press 1, then 0.

To select No.25, press 2, then 5.

Installing batteries

Install two "AAA/R03" batteries (not supplied) as shown below.

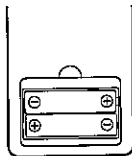
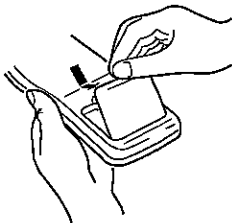

Remote control range

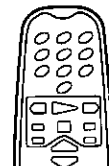
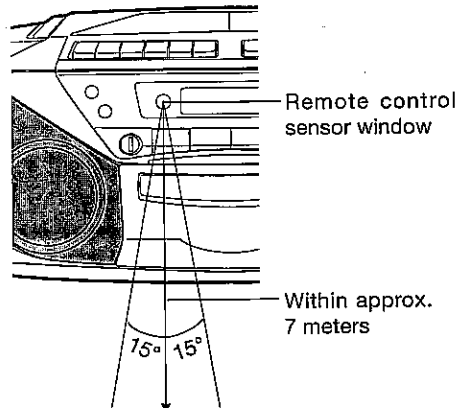

The buttons on the remote control perform similar functions to similarly marked buttons on the front panel.

GENERAL OPERATION

Adjusting the volume

Turn the VOLUME control (or press the + or -VOLUME button on the remote control). The volume level appears on the display (VOL 0 to VOL 40).

Q sound button

Press the QSOUND button to ON. A 3 dimensional sound effect is created.

Bass expander button

Press the BASSXPANDER button to ON to enhance the bass sound.

Note:

If the volume level is set to "VOL. 30" or more, the bass expander effect may reduce depending on the input sources.

Headphones

Connect stereo headphones (not supplied) to the PHONES socket for monitoring or for private listening. The speakers are automatically disconnected when headphones are connected.

WHAT TO DO IF ...

If the operation of the unit or display is not normal,

1. Set the function (TAPE/CD/RADIO) switch to CD or RADIO.
2. Disconnect the mains lead from the unit and remove all batteries.
3. Press the BAND button on the front panel for at least 1 minute.
4. Connect the mains lead, and install all batteries.
5. Operate the unit.

CD PLAY

Use compact discs bearing the symbol shown below. In addition to conventional 12 cm CDs, this system can be used to play 8 cm CDs without an adapter.



1. Set the function (TAPE /CD/RADIO) switch to CD.
2. Press the CD OPEN button. The CD compartment opens.
3. Place the disc with the label facing up on the turntable. (Place only one disc at a time.)

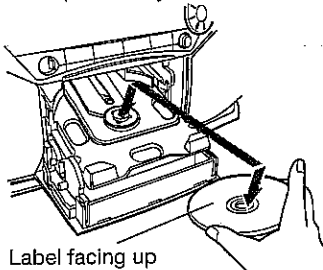

4. Press the CD compartment to close it.

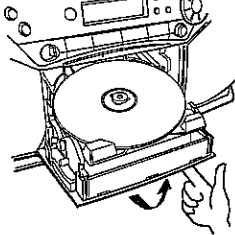

The total playing time and total number of tracks on the disc appear.

5. Press the PLAY/PAUSE button.

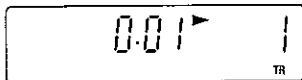

"▶" appears, and play starts from the first track. The elapsed playing time for the current track and track number are displayed.

- To start play from the desired track, select the track by using the SKIP/SEARCH buttons (or number buttons on the remote control), then press the PLAY/PAUSE button.

Note:

If a disc is loaded upside down, or if no disc is loaded, the CD player will not operate.

6. Press the STOP/CLEAR button to end disc play.
When the last track has been played, the player stops automatically.
7. To turn the CD player off, set the function switch to TAPE/OFF.

Note:

Do not open the CD compartment during CD play. Always press the STOP/ CLEAR button and wait for the disc to stop rotating before opening the CD compartment.

Notes on handling compact discs

- Do not expose the disc to direct sunlight, high humidity or high temperatures for extended periods of time.
- Discs should be returned to their cases after use.
- Do not apply paper or write anything on the disc surface.
- Handle the disc by its edge. Do not touch the playing surface (glossy side).
- Fingerprints and dust should be carefully wiped off the playing surface of the disc with a soft cloth.
Wipe in a straight motion from the centre to the outside of the disc.
- Never use chemicals such as record cleaning sprays, antistatic sprays or fluids, benzene or thinner to clean compact discs.

Temporarily stopping play

Press the PLAY/PAUSE button. "▶" blinks. To resume play, press the button again.

Skip play

To skip to track 6 while track 3 is playing, press the "▶▶|" SKIP/SEARCH button repeatedly until "6" appears (in the track section) on the display. To skip back to track 3 while track 6 is playing, press the "||◀◀" SKIP/SEARCH button repeatedly until "3" appears.

- The number buttons on the remote control can also be used for skip play. To skip to track 6 while one track is playing, press 0, then 6.

Search (forward/reverse)

If the "▶▶|" or "||◀◀" SKIP/SEARCH button is pressed during play, the player will search at high speed in the forward or reverse direction while the button is being pressed. When the button is released, normal play will continue.

Repeat play

Press the REPEAT button before or during play. The player will play all the tracks or all the programmed tracks repeatedly. "REP" appears. To cancel repeat play, press the REPEAT button again. "REP" disappears.

PROGRAMMED PLAY

Up to 20 tracks on a disc can be programmed for play in any order.

- To begin the programming procedure, select "CD" function first.
- The same track can be programmed more than once.
- Load a disc that you want to programme before starting programmed play.

1. Press the STOP/CLEAR button.
2. Press the MEMORY button.

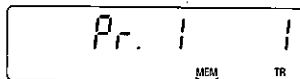

3. Select a track by using the SKIP/SEARCH buttons.
 - The number buttons on the remote control can also be used.

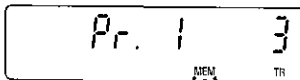

4. Press the MEMORY button. "MEM" remains lit.
 5. Repeat steps 3 - 4 to programme additional tracks.
 6. Press the PLAY/PAUSE button to start play. When all programmed tracks have been played, the player stops automatically.
 - The programme contents are retained in memory.
- Any attempt to programme more than 20 tracks will result in "FULL" being displayed and discontinuation of the programming.
 - To cancel programmed play, press the STOP/CLEAR button twice.

Checking the programme

Each time the MEMORY button is pressed in the stop mode, the programmed details sequentially appear on the display.

LISTENING TO TAPES

1. Set the function (TAPE /CD / RADIO) switch to TAPE.
2. Press the STOP/ EJECT button. The cassette holder opens.
3. Load the cassette into the cassette holder.

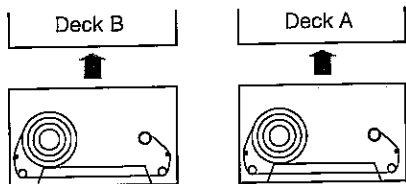

After loading the cassette, press the cassette holder back into position.

4. Press the PLAY button (Deck A or B) to begin playback. "TAPE" appears on the display.
5. Press the STOP/ EJECT button to stop playback at any time. Press it again to remove the cassette.

When the end of the tape has been reached, the tape stops automatically.

Note:

- Use the normal tape (TYPE 1).
- Endless tapes cannot be used.
- Do not use C-100 (or longer) tapes. They may jam in the mechanism.

Pause

Press the PAUSE button to temporarily stop playback or recording. Press it again to resume operation.

Fast forward and rewind

Press the FFWD or REW button. When the desired location has been reached, press the STOP/ EJECT button.

Continuous playback (Deck A to B)

Press the PLAY button on deck A, PAUSE button on deck B, then PLAY button on deck B. Deck A plays back first and stops automatically at the end of the tape. Then the tape on deck B starts and stops automatically.

LISTENING TO THE RADIO

Automatic /Manual tuning

1. Set the function switch to RADIO. The radio frequency appears.
2. Select the desired radio band with the BAND button.
3. Automatic tuning:
Press the TUNING UP or TUNING DOWN button for at least 1 second to tune in a station. The unit will scan up or down the band and receive the next receivable station. Press the button again to continue.

Manual tuning:

Press the TUNING UP or TUNING DOWN button briefly until the desired frequency is displayed.

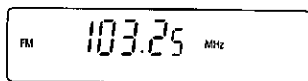

4. To turn the radio off, set the function switch to TAPE/OFF.

To receive FM stereo broadcasts

Make sure that "MONO" is not displayed. If "MONO" appears, press the FM MODE button to turn the "MONO" indication off.

"ST" appears when an FM stereo broadcast is received.

- If the signal from an FM stereo station is weak and reception is poor, press the FM MODE button to change to the MONO mode. The reception may be improved, but the sound will be monaural.

To improve reception

FM: Pull out the telescopic aerial and adjust its position.

AM: Rotate the unit.

To preset stations

Up to 20 FM and 12 AM stations can be preset.

1. Tune in the station to be preset as described above.
2. Press the MEMORY button.

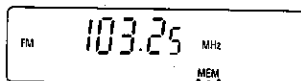

3. While "MEM" is blinking, press the PRESET button to select the channel to be preset.

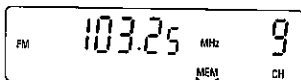

4. While "MEM" is blinking, press the MEMORY button. "MEM" disappears.
 - In this example, "103.25 MHz" FM station is preset on FM channel 9.
 - The number buttons on the remote control can also be used. In this example, press 0, then 9 after the step 2 above.
5. Repeat steps above to add more preset stations.
 - When presetting a new station, the previous preset station is cleared.

Listening to preset stations

1. Select "RADIO" function and select the band.
2. Press the PRESET button briefly.
 - The number buttons on the remote control can also be used.

Preset scan tuning

1. Select "RADIO" function and select the band.
2. Press the PRESET button for at least 1 second. "PS" blinks on the display. Each of the preset stations is tuned in for 5 seconds.
3. When the desired station has been tuned in, press the PRESET button again to keep the reception locked at that station.

RECORDING

Recording copyright material without permission of the copyright owners is usually an infringement. If you wish to re-record copyright material, permission from the copyright owner is necessary. SANYO does not approve of, and cannot be held responsible for, any unlawful use of this machine.

Use deck B for recording.

Recording compact discs (Synchronous recording)

1. Load a blank cassette.
2. Select "CD" function.
3. Load the disc to be recorded.
 - Select the track number if required.
 - For programmed recording, programme the material in advance (as described under "PROGRAMMED PLAY").
4. Press the REC button. The PLAY button is engaged simultaneously and CD recording starts.
 - When you want to record music as you listen, press the REC button. Recording starts automatically from the beginning of the track.
5. Press the STOP/EJECT button to stop recording.
When the end of the tape is reached, the CD player and deck stop automatically.

Recording from the radio

1. Load a blank cassette.
2. Tune in the radio station to be recorded.
3. Press the REC button to start recording.
4. Press the STOP/EJECT button to stop recording.

When beat is heard

Beat (a high-pitched noise) may sometimes be heard during the recording of radio broadcasts. If this occurs, set the BEAT CANCEL switch to the position that reduces the level of the beat noise.

Safeguards against accidental erasure

To protect side A, break out tab (1). To protect side B, break out tab (2).

- To erase or record a protected cassette, cover the tab openings with adhesive tape (3).

Note:

The REC button cannot be depressed when using a protected cassette.

TAPE DUBBING (Deck A to B)

1. Load the cassette to be played back into deck A and a blank cassette into deck B.
2. Set the cassette in deck A to the point where recording will begin.
3. Press the PAUSE button on deck B.
4. Press the REC button on deck B.
5. Press the PLAY button on deck A to start dubbing.
6. To stop dubbing, press both STOP/EJECT buttons.

Automatic stop during dubbing

- If deck B stops automatically, deck A continues playback mode.
- If deck A stops automatically, deck B erases the tape to the end.

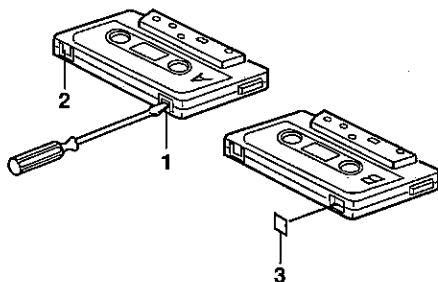

MAINTENANCE

Cleaning the unit

Clean the outside of the unit with a clean soft cloth, moistened with lukewarm water. Do not use benzene, thinners, or alcohol since they will mar the finish of the surfaces.

Cleaning the tape heads and tape path

To ensure continued high performance, use a cleaning tape (available from your local audio dealer) to clean the head block of the deck after about every 10 hours of use.

Cleaning the CD player lens

The lens should never be touched. If dust is on the lens, blow it off using a camera lens blower. (Consult your dealer.)

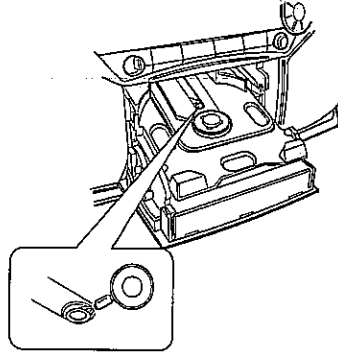

SPECIFICATIONS

CD Player

Channels:

2-channel stereo

Sampling frequency:

44.1 kHz

Pick-up :

Semiconductor laser

Laser output:

0.6mW (Continuous wave max.)

Wave length:

790 nm

Wow & Flutter:

Below measurable limits

Radio

Reception frequency:

FM: 87.5 ~ 108 MHz

AM: 522 ~ 1,611 kHz

Cassette deck

Track system:

4-track, 2-channel stereo

Erasing system:

Magnet erase

Tape speed:

4.75 cm/sec.

Frequency response:

80 ~ 12,000 Hz

Fast forward / rewind time:

Approx.110 sec. (C-60)

General

Output power :

4W/ch (DC max.)

Speakers:

8 cm x 2, 6 cm x 2

Terminals:

PHONES: 32 ohms

Power source:

AC:230-240V,50Hz

DC:12V, 8 "D/R20" batteries

Dimensions:

454(W) x 175(H) x 224 (D)mm

Weight :

approx.4.9 kg (including batteries)

Specifications subject to change without notice.

SANYO