

# SANYO

---

**INSTRUCTION MANUAL**

**MCD-Z8F**

**CD Portable Stereo Radio  
Cassette Recorder**

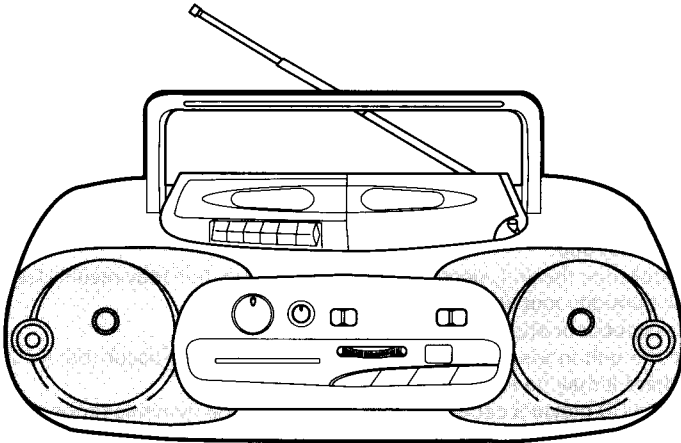

## CAUTION

USE OF CONTROLS OR ADJUSTMENTS OR PERFORMANCE OF PROCEDURES OTHER THAN THOSE SPECIFIED IN THE OPERATING INSTRUCTIONS MAY RESULT IN HAZARDOUS RADIATION EXPOSURE.

THE COMPACT DISC PLAYER SHOULD NOT BE ADJUSTED OR REPAIRED BY ANYONE EXCEPT PROPERLY QUALIFIED PERSONNEL.

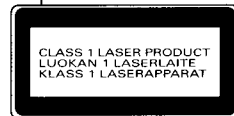
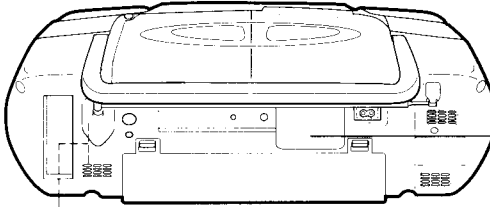

CAUTION - INVISIBLE LASER RADIATION WHEN OPEN AND INTERLOCKS DEFEATED. AVOID EXPOSURE TO BEAM.

ADVARSEL - USYNLIG LASER STRÅLING VED ÅBNING, NÅR SIKKERHEDSAFBRYDERE ER UDE AF FUNKTION, UNDGÅ UDSÆTTELSE FOR STRÅLING.

VARNING - OSYNLIG LASER STRÅLNING NÅR DENNA DEL ÄR ÖPPNAD OCH SPARR ÄR URKOPPLAD. STRÅLEN ÄR FARLIG.

VORSICHT - UNSICHTBARE LASERSTRAHLUNG TRITTT AUS, WENN DECKEL GEOFFNET UND WENN SICHERHEITSVERRIEGELUNG ÜBERBRÜCKT IST. NICHT, DEM STRAHL AUSSETZEN.

VARO! Avattaessa ja suojalukitus ohitettaessa olet alttiina näkymättömälle lasersäteilylle. Älä katso säteeseen.



## FOR SAFE AND EFFICIENT OPERATION

- The apparatus shall not be exposed to dripping or splashing.
- Do not damage the mains lead.
- When not in use, disconnect the mains lead from the outlet. Grasp the plug, not the lead, when disconnecting the unit.
- If water should enter the unit, electrical shock or a malfunction may result. Use in an area where there is low humidity and little dust.
- Do not disassemble or alter the unit in any way.
- Do not use the unit in areas where extremes in temperature occur (below 5°C or exceeding 35°C), or where it may be exposed to direct sunlight.
- Because of the CD player's extremely low noise and wide dynamic range, there is a tendency to turn the volume on the amplifier higher than necessary. Doing so may produce an excessively high output from the amplifier which can cause damage to your speakers. Please be careful in this regard.
- Sudden changes in the surrounding temperature can cause dew to form on the optical pickup lens inside the unit. Under this condition the unit may be unable to operate properly. If this should occur, remove the disc and allow the player to adjust to the surrounding temperature.

# POWER SUPPLY

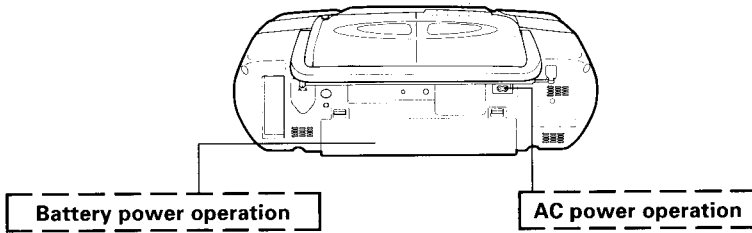

**Install batteries.**  
**Observe + and - signs.**

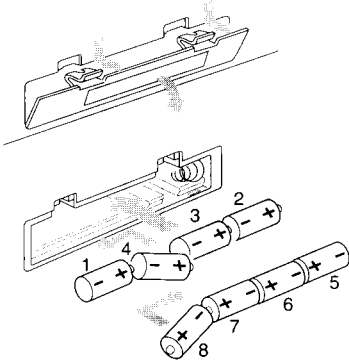

**8 "D" size batteries**

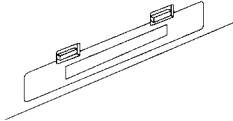

**Replace lid.**

**Take out the cord and connect it.**

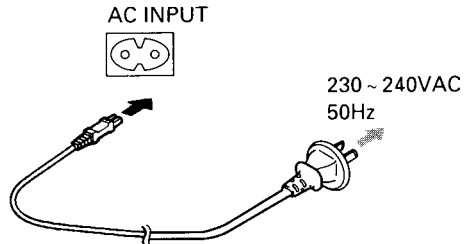

**NOTE:**

*When the mains lead is connected to the unit, the installed batteries will be automatically disconnected.*

## **CAUTION:**

### **WHEN INSTALLING THE BATTERIES**

To prevent leakage from the batteries, which is corrosive and can cause personal injury and damage to the unit, observe the following precautions:

1. The batteries must be installed correctly. Match the polarities (+ and - signs) on the batteries, to the polarities shown on the back of the unit.
2. Do not mix new batteries with old or used batteries.
3. Only use batteries of the same type and brand.

4. If the unit will not be used for an extended period of time, remove the batteries and store them in a cool place.
5. Carefully follow the battery manufacturer's instructions for proper use and disposal.
6. **DO NOT ALLOW YOUNG CHILDREN TO HANDLE BATTERIES.**

**NOTE:**

*When the batteries have become discharged, they must be disposed of in a safe manner which complies with all applicable laws.*

# COMPACT DISC OPERATION

## CD PLAY

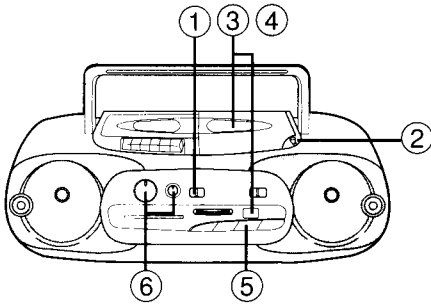

④ Push down to close.

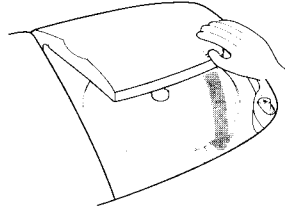

① To CD.

FUNCTION

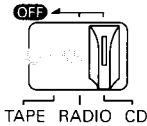

② Push button to open.

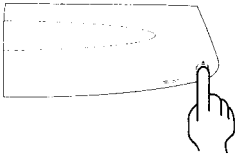

③ Insert CD.

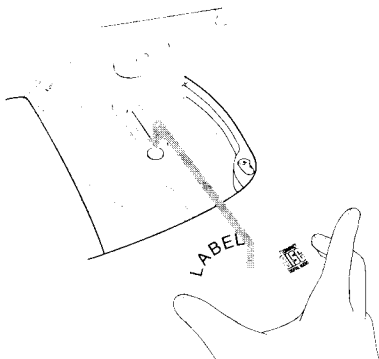

The CD TRACK NO. display will show the total number of tracks on the disc as shown below.

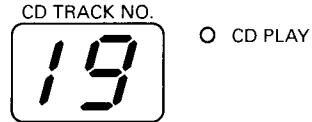

tracks	CD TRACK NO. display
1 ~ 19	1 ~ 19
More than 19	"0" Flashes

⑤ Press PLAY/PAUSE.

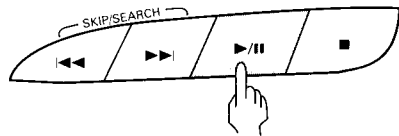

The CD PLAY indicator will light.

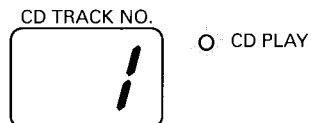

## ⑥ To adjust the sound.

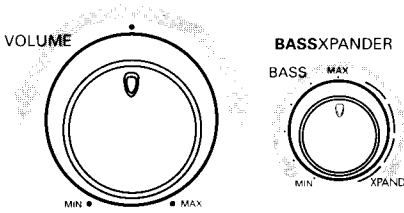

## Press STOP.

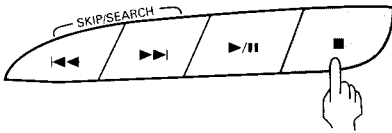

## To OFF (TAPE)

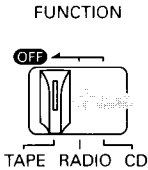

## CAUTION!

- **If a disc is loaded upside down, or if no disc is loaded, the CD player will not operate.**
- **Opening the CD compartment lid while a CD is playing could scratch the disc. Always press the STOP button and wait for the disc to stop rotating before opening the CD compartment lid.**

## Compact discs

- Both 8 cm and 12 cm discs can be played in this unit.
- NOTE: Place only one disc at a time in the CD compartment.
- Only discs bearing the logo as shown can be played in this unit.



- Always place the compact disc in the CD compartment with the label facing up. Compact discs can be played on only one side.
- Fingerprints and dust should be carefully wiped off the disc's signal surface (opposite the label side) with a soft cloth. Gently wipe in a straight motion from the inside to the outside of the disc.
- Discs should be returned to their cases after use to avoid serious scratches which could cause the player to skip.
- Do not expose a disc to direct sunlight, high humidity, or high temperatures for extended periods of time to prevent warping the disc.
- Do not apply paper or write anything on the surfaces of the disc.
- Do not use cleaners or antistatic sprays on discs, such as those used for phonograph records.

## IMPORTANT NOTE

If an abnormal display indication, or an operating problem occurs, disconnect the mains lead. Remove the D batteries (see page 2). Wait at least 5 seconds, then reconnect the mains lead. Reinstall the D batteries.

## PAUSE MODE

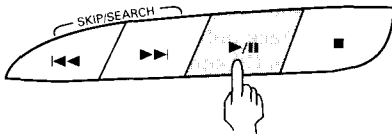

1. Press the PLAY/PAUSE button to temporarily stop play. The CD PLAY indicator will flash.
2. Press it again to continue. The CD PLAY indicator will stop flashing.

## TRACK SEARCH

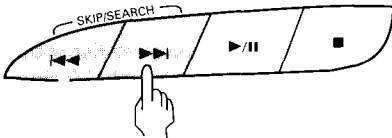

**Press and hold down during playback**

1. In the play mode, press and hold the ◀◀ or ▶▶ SKIP/SEARCH button to lower the volume level and advance or return to any part of the disc. The CD TRACK NO. display will flash.
2. Release the ◀◀ or ▶▶ SKIP/SEARCH button to return the volume level to normal and resume play.

### NOTE:

*If the ◀◀ or ▶▶ SKIP/SEARCH button is pressed during the PAUSE mode, no sound will be heard, and the PAUSE mode will continue when the button is released.*

## TRACK SKIP

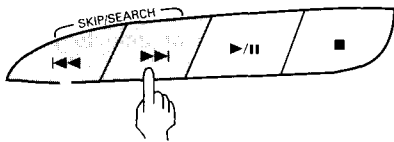

**Press and release repeatedly**

1. Press and release the ◀◀ or ▶▶ SKIP/SEARCH button during play to advance or return to the beginning of any track on the disc.
2. The CD TRACK NO. display will show the number of the selected track. Play will continue from the beginning of the new track.

### NOTE:

*If the ◀◀ or ▶▶ SKIP/SEARCH button is pressed while the unit is in the PAUSE mode, the unit will remain in the PAUSE mode when the button is released.*

## Using Headphones

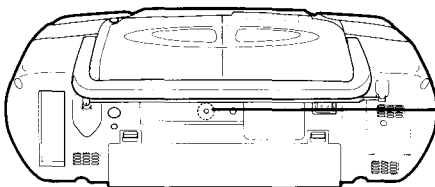

# RADIO OPERATION

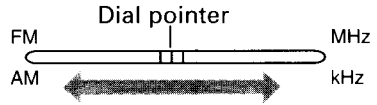
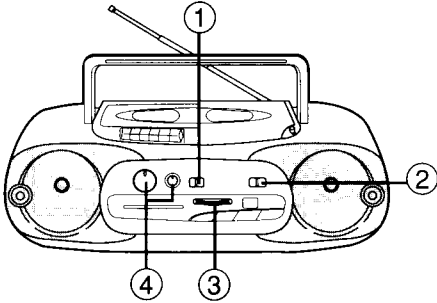

**NOTE:**

*The unit will automatically switch to stereo when an FM stereo broadcast is received.*

**① To RADIO.**

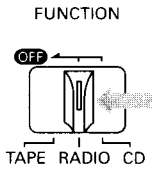

**② To AM or FM.**

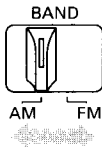

**④ To adjust the sound.**

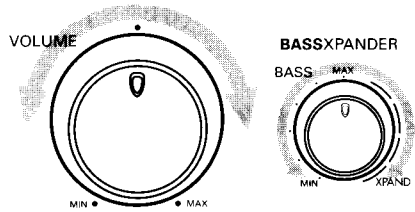

**To OFF (TAPE).**

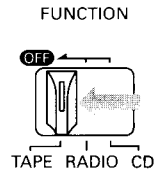

**③ Tune in a station.**

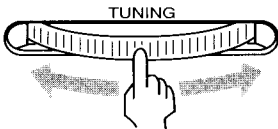

## To improve reception

**FM - Extend and change position.**

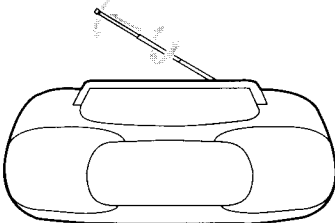

**AM - Rotate unit.**

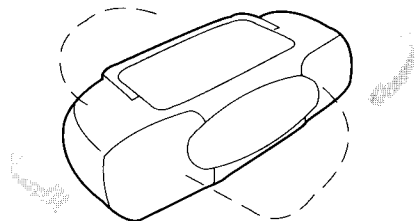

# CASSETTE TAPE OPERATION

## CASSETTE PLAYBACK

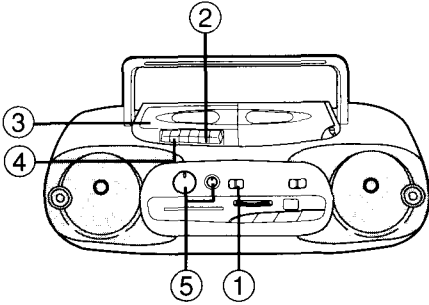

### ① To TAPE. FUNCTION

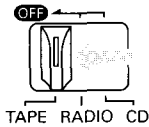

### ② Press STOP/EJECT.

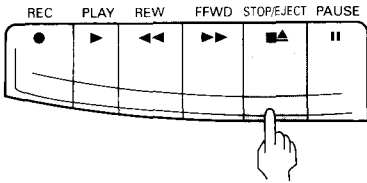

### ③ Insert cassette. Close the cassette lid.

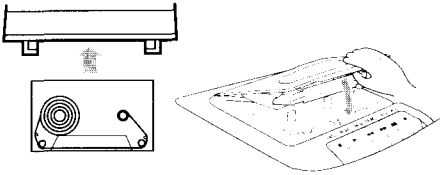

### ④ Press PLAY.

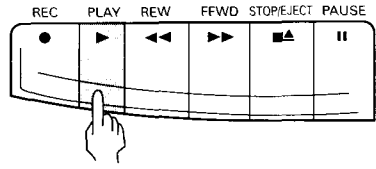

### ⑤ To adjust the sound.

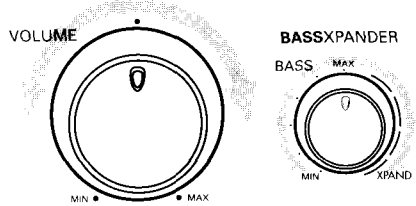

### Press STOP/EJECT.

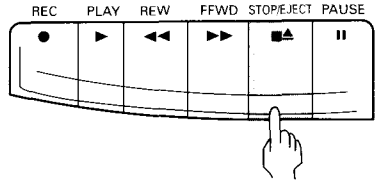

Press STOP/EJECT once to stop the tape.  
Press again to remove the cassette.

#### Full automatic stop

This unit has a full-release stop system to protect the tape and prevent pinch roller damage. When the end of the tape is reached in Playback, Recording, Fast forward or Rewind, the tape mechanism will automatically stop.

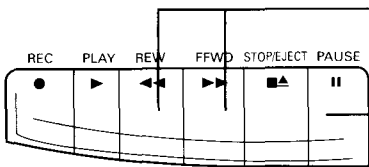

### REWIND/FAST FORWARD MODE

1. Press to wind the cassette backward or forward.

### PAUSE MODE

1. Press the PAUSE button to temporarily stop play during play or record mode.
2. Press it again to continue.



# RECORDING (RADIO)

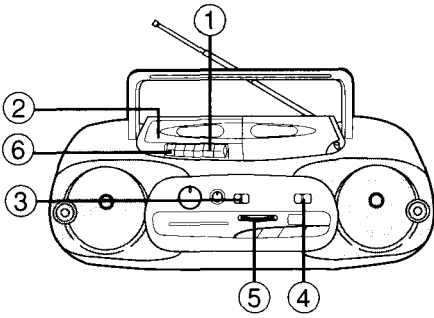

## ① Press STOP/EJECT.

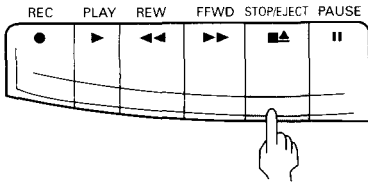

## ② Insert cassette. Close the cassette lid.

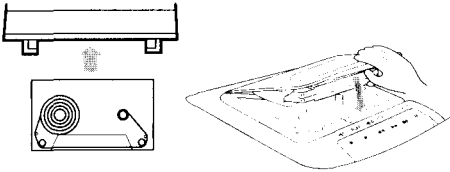

## ③ To RADIO.

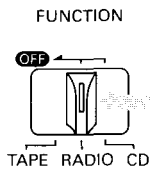

## ④ To AM or FM.

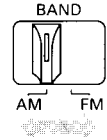

## ⑤ Tune in a station.

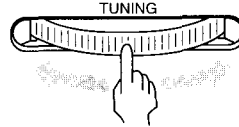

## ⑥ Press REC.

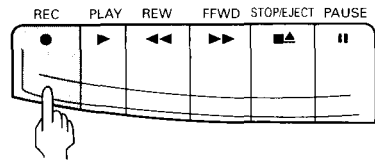

## Press STOP/EJECT.

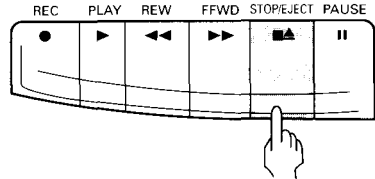

Press STOP/EJECT once to stop the tape. Press again to remove the cassette.

### Automatic Level Control (ALC) recording

The ALC circuit adjusts the recording input level automatically. No adjustments are required.

## Safeguards against accidental erasure

To protect side A, break out tab (1). To protect side B, break out tab (2).

### NOTE:

A cassette with the erase guard tabs removed cannot be erased or used for recording and the REC button cannot be depressed. To record or erase a protected cassette, cover the tab openings with adhesive tape (3).

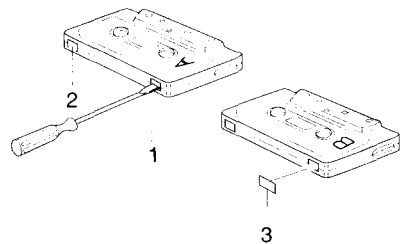

## RECORDING (CD)

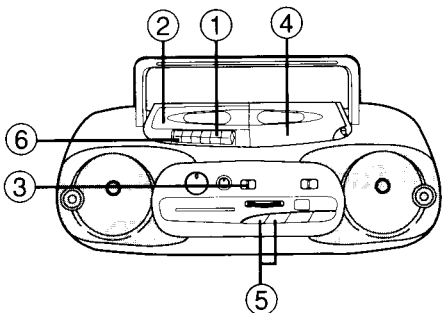

### Synchronous recording

(CD-to-TAPE SYNCHRO DUBBING)

This recording system starts disc play and cassette recording at the same time.

When the REC button is pressed, recording will start at the beginning of track number 1 of the disc.

To begin play from a different track press the ►► SKIP/SEARCH button to select the desired track number, then press the REC button.

### ① Press STOP/EJECT.

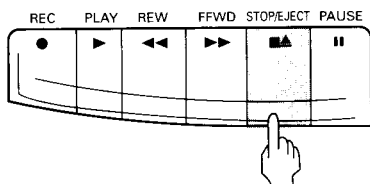

### ② Insert cassette. Close the cassette lid.

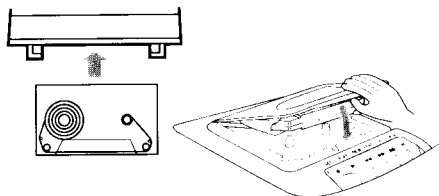

### ③ To CD.

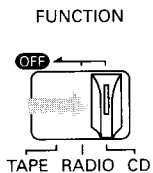

### ④ Insert CD.

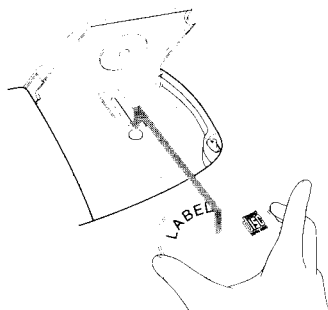

### ⑤ Press SKIP/SEARCH to select track to record.

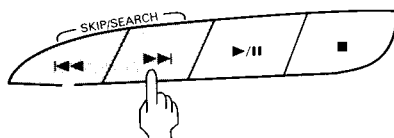

### ⑥ Press REC.

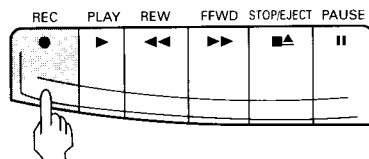

### WARNING

Recording copyright material without permission of the copyright owners is usually an infringement. If you wish to re-record copyright material, permission from the copyright owner is necessary. SANYO does not approve of, and cannot be held responsible for, any unlawful use of this machine.

# MAINTENANCE

## Cleaning the tape heads

If dust or reddish-brown oxide builds on the tape heads, pinch roller, or capstan, the following may result:

1. Poor sound quality during playback
2. Distorted, poor quality recordings
3. Erratic tape speed during recording or playback

1. Press the STOP/EJECT button to open the cassette compartment lid.

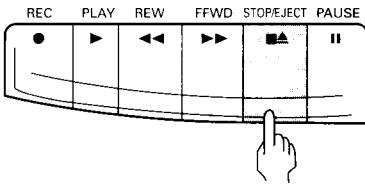

2. Press the REC button while holding the lever down as shown.

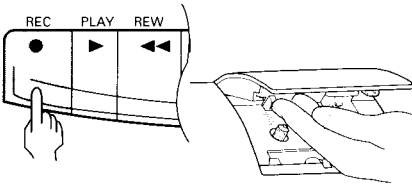

3. Moisten a cotton swab (1) with Isopropyl alcohol or special head cleaning fluid. Gently rub the face of each head (4, 5) with alcohol. Also clean the capstan (2) and pinch roller (3).

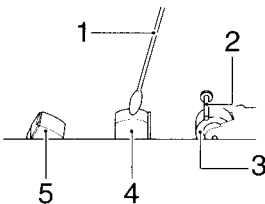

## Cleaning the unit

Wipe the outside of the unit with a clean soft cloth, moistened with lukewarm water and wrung dry. Do not use solvents such as benzene or thinner which will permanently damage the surface of the unit.

## Cleaning the CD player lens

The lens should never be touched. If dust is on the lens, blow it off using a camera lens blower. (Please consult your dealer.)

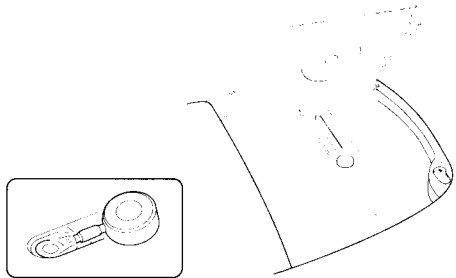

## If trouble occurs...

To avoid the hazard of electric shock and damage to the unit, have the unit bench tested by an authorized SANYO service station. Do not remove the unit from its cabinet to attempt repairs yourself.

# SPECIFICATIONS

## (CASSETTE SECTION)

Recording system:

AC bias, 4-track stereo

Erasing system:

Magnet erase

Tape speed:

4.75 cm/sec.

Fast forward and rewind time:

110 sec. (C-60 tape)

Frequency response:

80 ~ 12,000 Hz (Normal tape)

## (CD SECTION)

Channels:

2 channels

S/N ratio:

70 dB

Wow & Flutter:

undetectable

Sampling frequency:

44.1 kHz

Quantization:

16 bits linear/ch

Pick up light source:

Semi-conductor laser

Pick up wave length:

790 nm

Laser output:

Continuous wave max. 0.6 mW

## (RADIO SECTION)

Tuning ranges:

AM: 525 – 1,710 kHz

FM: 88 – 108 MHz

Aerials:

Built-in ferrite bar and telescopic aerials

## (GENERAL)

Output power:

4.0 W/ch (DC max.)

Speaker:

12 cm x 2, 4 ohms

PIEZO x 2

Terminal impedance:

PHONES: 32 ohms

Power source:

AC: 230 ~ 240 V, 50 Hz

DC: 12 V (8 "D" size batteries)

Dimensions:

556 x 170 x 220 mm (W x H x D)

Weight (approx.):

3.3 kg without batteries

Specifications subject to change without notice.

# SANYO