

INSTRUCTION MANUAL

MCD-ZX380F MCD-ZX390F

CD Portable Radio Cassette Recorder

MCD-ZX380F

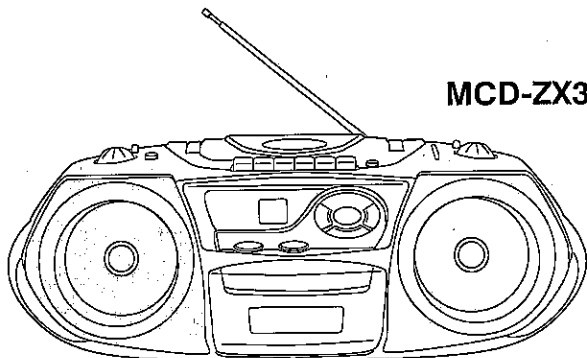

MCD-ZX390F

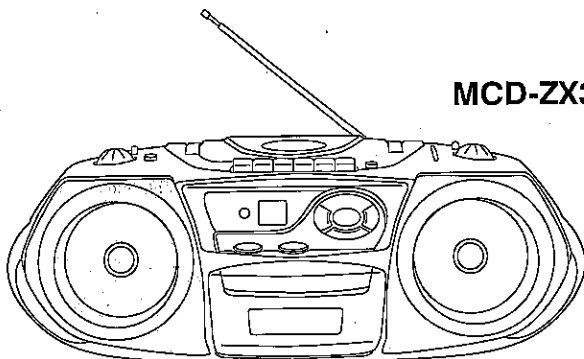
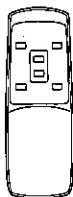

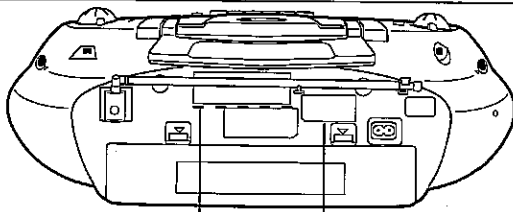

CAUTION-INVISIBLE LASER RADIATION WHEN OPEN AND INTERLOCKS DEFEATED. AVOID EXPOSURE TO BEAM.

ADVARSEL-USYNLIG LASER STRÅLING VED ÅBNING, NÅR SIKKERHEDSAFBRYDERE ER UDE AF FUNKTION, UNDGÅ UDSÆTTELSE FOR STRÅLING.

VARNING-OSYNLIG LASER STRÅLNING NÅR DENNA DEL ÄR ÖPPNAD OCH SPÄRR ÄR URKOPPLAD. STRÅLEN ÄR FARLIG.

VORSICHT! -UNSICHTBARE LASERSTRAHLUNG TRITT AUS, WENN DECKEL GEÖFFNET UND ENN SICHERHEITSVERRIEGELUNG ÜBERBRÜCKT IST. NICHT, DEM STRAHL AUSSETZEN.

VARO !-Avattaessa ja suojalukitus ohitettaessa olet alttiina näkyttömälle lasersäteilylle. Älä katso säteeseen.



CLASS 1 LASER PRODUCT
LUOKAN 1 LASERLAITE
KLASS 1 LASERAPPARAT

CAUTION - USE OF CONTROLS OR ADJUSTMENTS OR PERFORMANCE OF PROCEDURES OTHER THAN THOSE SPECIFIED IN THE OPERATION INSTRUCTION MAY RESULT IN HAZARDOUS RADIATION EXPOSURE.

THIS PRODUCT SHOULD NOT BE ADJUSTED OR REPAIRED BY ANYONE EXCEPT PROPERLY QUALIFIED PERSONNEL.

- The apparatus shall not be exposed to dripping or splashing.
- Do not use where there are extremes of temperature (below 5°C or exceeding 35°C).
- Because of the CD player's extremely low noise and wide dynamic range, there might be a tendency to set the volume on the amplifier unnecessarily high. Doing so may produce an excessively large output from the amplifier which could damage your speakers.
- Sudden changes in the ambient temperature may cause condensation to form on the optical lens inside the unit. If this happens, take out the disc, leave the unit for about 1 hour, and then proceed to operate.
- Do not install this equipment in a confined space, such as a book case or built in cabinet.
- The rating label is located on the back of the unit.
- No objects filled with liquids, such as vases, shall be placed on the apparatus.

CONTROLS

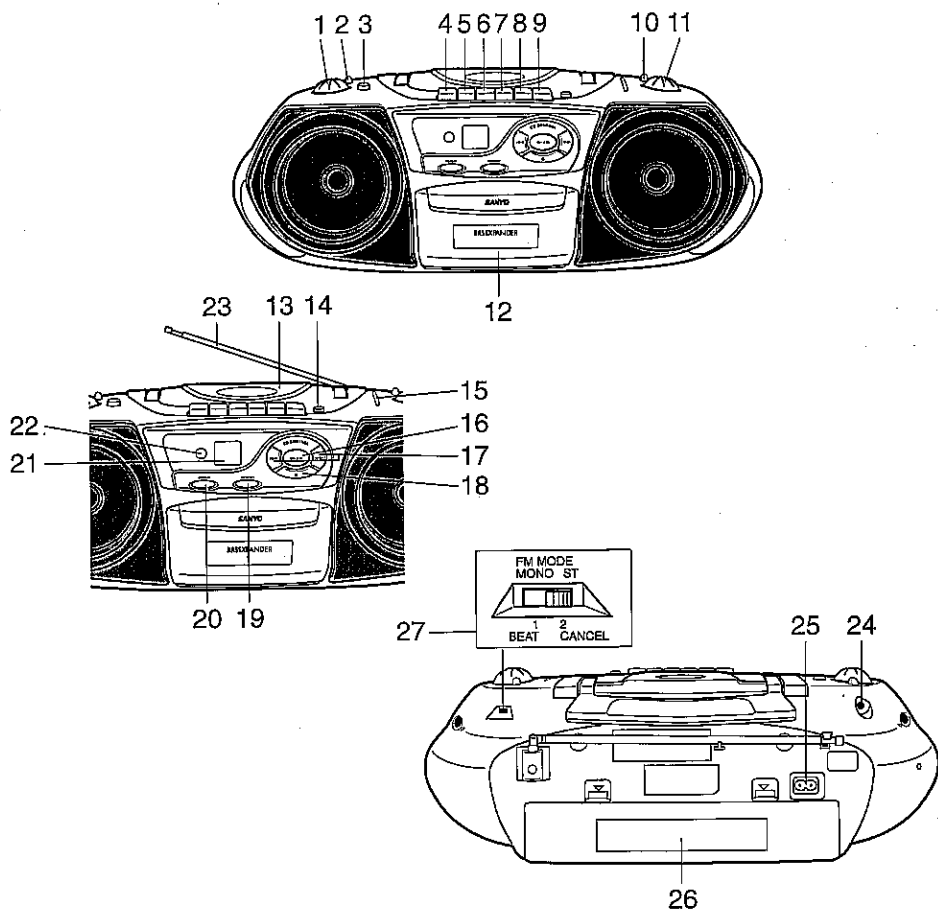

- | | |
|--|--|
| 1. Volume control (VOLUME) | 15. Frequency indicator |
| 2. Function switch (FUNCTION) | 16. Play/Pause button (▶/) |
| 3. Bass expander button (BASSXPANDER) | 17. Skip/Search buttons (◀◀, ▶▶) |
| 4. Pause button (PAUSE) | 18. Stop/Clear button (■) |
| 5. Stop/Eject button (STOP/EJECT) | 19. Memory button (MEMORY) |
| 6. Fast forward button (FFWD) | 20. Repeat button (REPEAT) |
| 7. Rewind button (REW) | 21. CD track number display (CD TRACK No.) |
| 8. Play button (PLAY) | 22. Remote sensor (IR) (MCD-ZX390F only) |
| 9. Recrd button (REC) | 23. Telescopic aerial |
| 10. Radio band switch (BAND) | 24. Headphones socket (PHONES) |
| 11. Tuning control (TUNING) | 25. AC input socket (AC INPUT) |
| 12. Cassette holder | 26. Battery compartment lid |
| 13. CD compartment lid. | 27. FM mode/Beat cancel switch |
| 14. CD compartment opening button
(CD OPEN) | (FM MODE/BEAT CANCEL) |

POWER SUPPLY

AC POWER

Connect one end of the mains lead to the AC INPUT socket and the other end to an AC outlet.

Note:

- The installed batteries are automatically disconnected when the mains lead is connected to the unit.
- The FUNCTION switch is mounted on the secondary side. The unit is not disconnected from mains, even switched off.

BATTERY POWER

Installing batteries

Install eight "D/R20" batteries (not supplied) as shown below.

Caution on batteries

To prevent battery electrolyte leakage, which may result in injury and damage to the unit or other objects, observe the following precautions:

1. All batteries must be installed with the proper polarity (see diagram on the rear of the unit).
2. Do not mix new with old or used batteries.
3. Only use batteries of the same type and brand.
4. Remove the batteries when they are not to be used for a long period time.
5. What the batteries have become discharged, they must be disposed of in a safe which complies with all applicable laws.

1

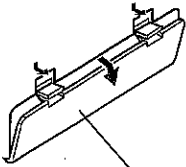

Battery compartment lid

2

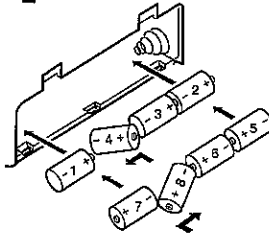

3

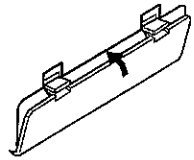

REMOTE CONTROL (MCD-ZX390F only)

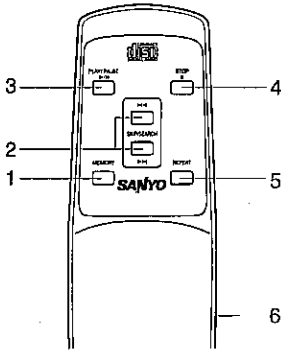

Controls

1. Memory button (MEMORY)
2. Skip/Search buttons (SKIP/SEARCH)
3. Play/Pause button (PLAY/PASUE)
4. Stop button (STOP)
5. Repeat button (REPEAT)
6. Battery compartment lid (back of the unit)

Installing batteries

Install two "R6/AA" batteries (not supplied) as shown below.

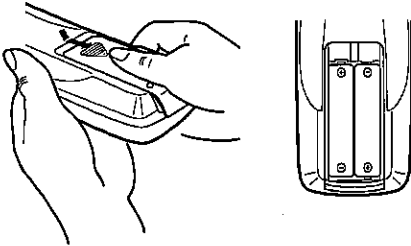

Remote control range

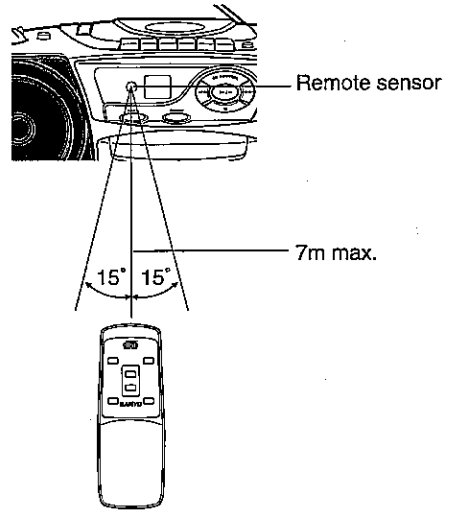

The buttons on the remote control perform similar functions to similarly marked buttons on the front panel.

GENERAL OPERATION

Adjusting the volume

Turn the VOLUME control.

Bass expander button

Press the BASSXPANDER button to ON to enhance the bass sound.

Headphones

Connect stereo headphones (not supplied) to the PHONES socket for monitoring or for private listening. The speakers are automatically disconnected when headphones are connected.

CD PLAY

Use compact discs bearing the symbol shown below. In addition to conventional 12 cm CDs, this system can be used to play 8 cm CDs without an adapter.



1. Set the FUNCTION switch to CD.
2. Press the CD OPEN button as shown below. The CD compartment opens.

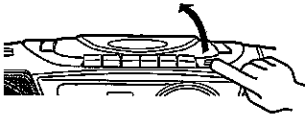

3. Place the disc with the label facing up on the turntable. (Place only one disc at a time.)

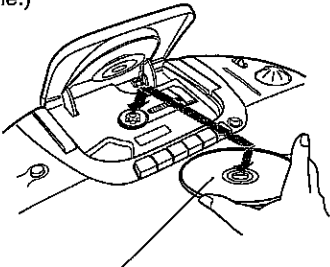

Label facing up

4. Press the CD compartment lid to close it. The total number of tracks on the disc appears on the CD TRACK No. display.

5. Press the ►/|| button.



The indicator on the ►/|| button lights and the current track number appears. Play starts from the first track.

- To start play from the desired track, select the track by using the ◀◀ or ▶▶ buttons, then press the ►/|| button.

Note:

If a disc is loaded upside down, or if no disc is loaded, the CD player will not operate.

6. Press the ■ button to end disc play. When the last track has been played, the player stops automatically.
7. To turn the CD player off, set the FUNCTION switch to TAPE/OFF.

Note:

Do not open the CD compartment during CD play. Always press the ■ button and wait for the disc to stop rotating before opening the CD compartment.

Notes on handling compact discs

- Do not expose the disc to direct sunlight, high humidity or high temperatures for extended periods of time.
- Discs should be returned to their cases after use.
- Do not apply paper or write anything on the disc surface.
- Handle the disc by its edge. Do not touch the playing surface (glossy side).
- Fingerprints and dust should be carefully wiped off the playing surface of the disc with a soft cloth.
Wipe in a straight motion from the center to the outside of the disc.
- Never use chemicals such as record cleaning sprays, antistatic sprays or fluids, benzene or thinner to clean compact discs.

Temporarily stopping play

Press the ►/II button. The indicator on ►/II button blinks. To resume play, press the button again.

Skip play

To skip to track 6 while track 3 is playing, press the ►►| button repeatedly until "6" appears on the display. To skip back to track 3 while track 6 is playing, press the |◄◄ button repeatedly until "3" appears.

Search (forward/reverse)

If the ►►| or |◄◄ button is pressed during play, the player will search at high speed in the forward or reverse direction while the button is being pressed. When the button is released, normal play will continue.

Repeat play

Press the REPEAT button before or during play (or programmed play). Each time the button is pressed, the repeat mode changes as follows.

The indicator on the REPEAT button blinks:

One track repeat mode.

The indicator on the REPEAT button lights:

All tracks repeat mode.

The indicator on the REPEAT button goes out:

Normal play mode.

PROGRAMMED PLAY

Up to 16 tracks on a disc can be programmed for play in any order.

- To begin the programming procedure, select "CD" function first.
- The same track can be programmed more than once.
- Load a disc that you want to programme before starting programmed play.

1. Press the ■ button if necessary.
2. Press the MEMORY button. The indicator on the MEMORY button and "P" blink.
3. Select a track by using the |◄◄, ►►| button.
4. Press the MEMORY button.
5. Repeat steps 3 - 4 to programme additional tracks.
6. Press the ►/II button to start play. The indicator on the MEMORY button remains lit. When all programmed tracks have been played, the player stops automatically.
 - The programme contents are retained in memory.

To cancel programmed play, press the ■ button twice.

Checking the programme

Press the MEMORY button twice in the stop mode, the programmed tracks sequentially appear on the display.

WHAT TO DO IF ...

If an abnormal display indication or an operating problem occurs, disconnect the mains lead and remove all batteries. Wait at least 5 seconds then reconnect the mains lead and reinstall the batteries. Resume the operation.

LISTENING TO TAPES

1. Set the FUNCTION switch to TAPE.
2. Press the STOP/EJECT button. The cassette holder opens.
3. Load the cassette into the cassette holder.

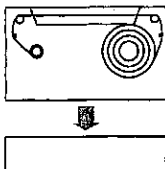

After loading the cassette, press the cassette holder back into position.

4. Press the PLAY button to begin playback.
 5. Press the STOP/EJECT button to stop playback at any time. Press it again to remove the cassette.
- When the end of the tape has been reached, the tape stops automatically.

Note:

- Use the normal tape (TYPE 1).
- Endless tapes cannot be used.
- Do not use C-100 (or longer) tapes. They may jam in the mechanism.

Pause

Press the PAUSE button to temporarily stop playback or recording. Press it again to resume operation.

Fast forward and rewind

Press the FFWD or REW button. When the desired location or end of the tape has been reached, press the STOP/EJECT button.

Automatic stop system

At the end of the tape while recording or playing back, the cassette deck stops automatically and the buttons are released.

This system does not work in fast forward and rewind operation. Be sure to press the STOP/EJECT button when the end of the tape has been reached.

Example (When using C-60 tape):

Press the STOP/EJECT button after approximately 2 minutes have elapsed under fast forward and rewind operation.

LISTENING TO THE RADIO

1. Set the FUNCTION switch to RADIO.
2. Select the desired radio band with the BAND switch.
3. Tune in a desired station by turning the TUNING control.
4. To turn the radio off, set the FUNCTION switch to TAPE/OFF.

To receive FM stereo broadcasts

Set the FM MODE switch (rear of the unit) to ST.

- If the signal from an FM stereo station is weak and reception is poor, set the FM MODE switch to MONO. The reception may be improved, but the sound will be monaural.

To improve reception

FM: Pull out the telescopic aerial and adjust its position.

AM: Rotate the unit.

RECORDING

Recording copyright material without permission of the copyright owners is usually an infringement. If you wish to re-record copyright material, permission from the copyright owner is necessary. SANYO does not approve of, and cannot be held responsible for, any unlawful use of this machine.

Recording compact discs (Synchronous recording)

1. Load a blank cassette.
2. Select "CD" function.
3. Load the disc to be recorded.
 - Select the track number if required.
 - For programmed recording, programme the material in advance (as described under "PROGRAMMED PLAY").
4. Press the REC button. The PLAY button is engaged simultaneously and CD recording starts.
5. Press the STOP/EJECT button to stop recording.

Recording from the radio

1. Load a blank cassette.
2. Tune in the radio station to be recorded.
3. Press the REC button to start recording.
4. Press the STOP/EJECT button to stop recording.

When beat is heard

Beat (a high-pitched noise) may sometimes be heard during the recording of radio broadcasts. If this occurs, set the BEAT CANCEL switch (rear of the unit) to the position that reduces the level of the beat noise.

Safeguards against accidental erasure

To protect side A, break out tab (1). To protect side B, break out tab (2) (Fig. 10).

- To erase or record a protected cassette, cover the tab openings with adhesive tape (3).

Note:

The REC button cannot be depressed when using a protected cassette.

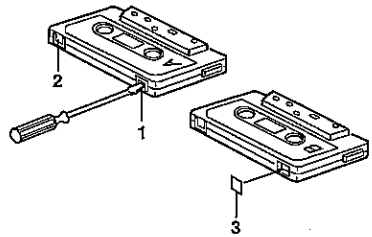

MAINTENANCE

Cleaning the tape heads

To ensure continued high performance, use a cleaning tape (available from your local audio dealer) to clean the head block of the deck after about every 10 hours of use.

Cleaning the unit

Clean the outside of the unit with a clean soft cloth, moistened with lukewarm water. Do not use benzene, thinners, or alcohol since they will mar the finish of the surfaces.

Cleaning the CD player lens

The lens should never be touched. If dust is on the lens, blow it off using a camera lens blower. (Consult your dealer.)

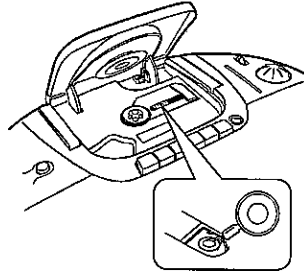

SPECIFICATIONS

CD Player

Channels:
2-channel stereo

Sampling frequency:
44.1 kHz

Pick-up :
Semiconductor laser

Laser output:
0.6 mW (Continuous wave max.)

Wave length:
790 nm

Wow/flutter:
Below measurable limits

Radio

Reception frequency:
FM: 87.5 ~ 108 MHz
AM: 526.5 ~ 1606.5 kHz

Cassette deck

Track system:
4-track, 2- channel stereo

Erasing system:
Magnet erase

Tape speed:
4.75 cm/sec.

Frequency response:
80 ~ 12,000 Hz

Fast forward/rewind time:
Approx.110 sec. (C-60)

General

Output power :
2 W/ch (DC max.)

Speakers:
10 cm x 2

Terminal:
PHONES: 32 ohms

Power source:
AC: 230 ~ 240V, 50Hz
DC: 12V, 8 "R20/D" batteries

Dimensions:
472(W) x 158(H) x 252(D) mm

Weight:
Approx. 3.0 kg (not including batteries)

Specifications subject to change without notice.

1994年8月17日

SANYO

SANYO Electric Co., Ltd.
Printed in China

(AU) 1AD6P1P1709--