

SANYO

Instruction
Manual

Video cassette
recorder

VHR-7500

VHS **HQ**
PAL

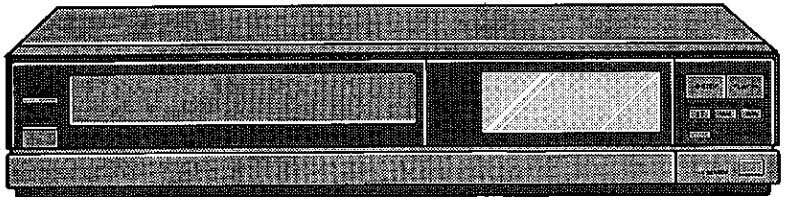
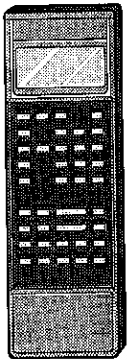

CONTENTS

Congratulations. You are now the owner of a SANYO Video Cassette Recorder. Please read these instructions before operating the VCR.



- This VCR is based on a VHS-PAL signal system. Only video cassette bearing the **VHS** symbol can be used.
- Video cassette recorders bearing the "HiQ" mark incorporate VHS high picture quality technology. Note that there is interchangeability with former VHS video cassette recorders.

PRECAUTIONS	2
FEATURES	3
DIRECT POWER ON AND GO SYSTEM	3
CONVENIENT AUTOMATIC FUNCTIONS	4
CONNECTIONS	5
ADJUSTING THE TV RECEIVER	6
PART NAMES AND FUNCTIONS	7
REMOTE CONTROL UNIT	9
CLOCK SETTING	11
TUNING CONTROL ADJUSTMENTS	12
CASSETTE LOADING AND UNLOADING	14
COUNTER MEMORY	15
RECORDING TELEVISION BROADCASTS	16
QUICK START RECORDING (QSR) TIMER	16
USING THE BLANK SEARCH FUNCTION	17
CAMERA RECORDING/ CAMCORDER DUBBING	18
DUBBING	18
TIMER RECORDING	19
PLAYBACK	22
FORWARD SEARCH	22
REVERSE SEARCH	22
STILL PICTURE	22
FRAME ADVANCE	22
SLOW MOTION	22
TRACKING ADJUSTMENT	23
PICTURE SHARPNESS ADJUSTMENT	23
TV MONITOR FUNCTION	23
TAPE REMAINDER	24
INDEX SEARCH FUNCTION	25
GO TO SEARCH FUNCTION	28
SPECIAL CODE FUNCTION	29
REPAIRS	30
TROUBLESHOOTING	30
SPECIFICATIONS	30

PRECAUTIONS

OPERATING PRECAUTIONS

- Removing the cabinet and touching the inside of the VCR with your hand, a screwdriver, or anything else, is not only harmful to the unit, but is also dangerous. **TO PREVENT FIRE OR SHOCK HAZARD, DO NOT EXPOSE THIS PRODUCT TO RAIN OR MOISTURE.**
- The unauthorized recording of television programmes, video tapes, films and other such material may infringe upon copyright or the rights of third parties.
- Be sure to use this VCR only in a temperature range of 5° C to 35° C and less than 85% humidity.
- This VCR is sensitive to magnetism. Do not expose to a magnetic source.
- Place the VCR on a flat, stable, level surface. Never subject it to violent shaking or any other shock or impact.
- Do not block the air vents that are provided to prevent the temperature inside the VCR from rising excessively.

The **POWER** button of this VCR is a secondary circuit, and does not disconnect the unit from an AC power source, even if the button is in the stand-by position, as long as the power cord is connected to an AC electrical outlet.

Note: Stand-by is the condition in which the digital display becomes dimmer and the date and time are displayed.

If the power supply cord of this appliance is damaged, it must be replaced. Return to a SANYO authorized service centre for replacement of the cord.

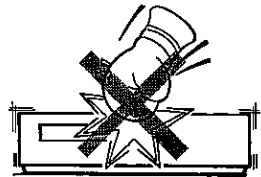
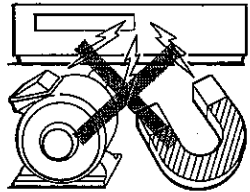
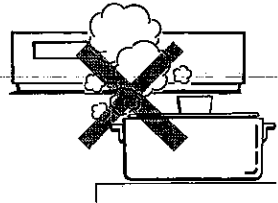
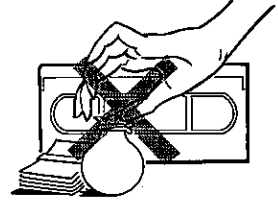
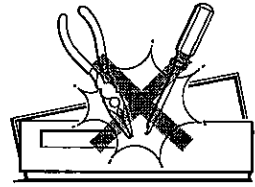

FEATURES

CAUTION

DEW SENSOR

When operating the VCR, always pay attention to the following.

- If the DEW indicator (00 00) illuminates, halt all operations until the DEW indicator goes off.
- Because condensation will form gradually, the DEW indicator may not illuminate immediately when the temperature or humidity has changed abruptly, even though dew has formed inside the VCR.
- Do not operate the VCR until its temperature has stabilized at the temperature of the room where it will be operated. This may take up to 20 minutes.

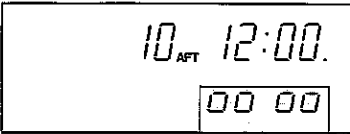

DEW Indicator

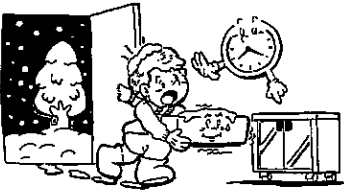

DIRECT POWER ON AND GO SYSTEM

Power on

If a control button is pressed while the VCR is in stand-by, power is supplied directly and the VCR operates.

Example: If you press the **PLAY** button, the VCR will be turned on and start playback.

Note: This function is not provided for the **REC** button. This is to prevent the VCR from being inadvertently put into a video recording condition. Normally, when only power on is required, press the **POWER** button.

Power off

The video recorder will be turned off if you press the **POWER** button.

CONVENIENT AUTOMATIC FUNCTIONS

Direct power on and go

When the VCR is in stand-by, press any one of the control buttons to turn on the power and perform the respective button's function.

AUTO power on

The power is automatically switched on as a cassette is inserted even when the VCR is in the stand-by condition.

MEP (Miss Erasure Prevention) eject

A video cassette will automatically be ejected if recording is attempted on a video cassette without an erasure-prevention tab.

Auto rewind

The VCR automatically rewinds the tape at the end of the tape.

Note: This function does not operate for timer recording or QSR timer recording.

Auto play

The VCR will playback a tape automatically when a video cassette is inserted whose erasure prevention tab has been removed.

Auto eject

When a video cassette without an erasure prevention tab is played to the end of the tape, the tape will be automatically rewound and then the cassette will be ejected.

Off power eject

A video cassette will be ejected when the **EJECT** button is pressed even with the VCR in stand-by condition.

Auto-timer stand-by

When timer setting is completed, the VCR's power is automatically switched off to timer stand-by mode.

CONNECTIONS

ANTENNA CONNECTION

- Un-plug the antenna cable from your TV receiver and reconnect to the terminal marked **"ANT IN"** on the VCR.
- Connect the antenna cable supplied as an accessory of the VCR to the **"ANT OUT"** terminal on the VCR. Connect the other end of this antenna cable to the TV receiver.
- Insert the plug of the power cord into the wall socket.

CONNECTING A COLOUR MONITOR

- Connect the **VIDEO/AUDIO OUT** terminals on the VCR to the video/audio terminals on the TV receiver.
- The advantage of this connection is a superior quality picture and sound during playback.

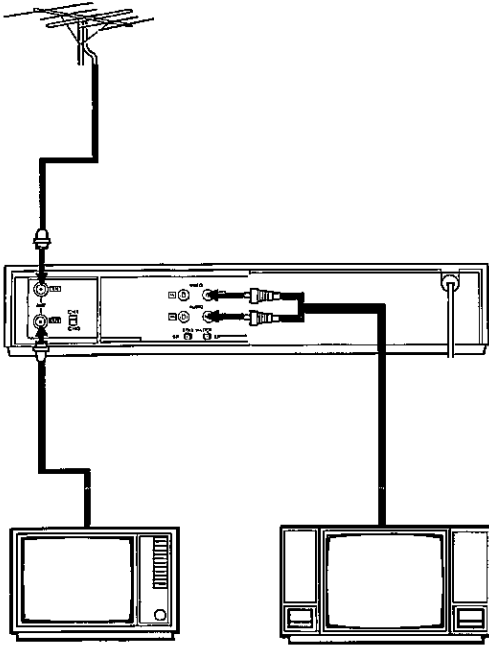

ADJUSTING THE TV RECEIVER

The VCR channel for this equipment is either channel 0 or 1. Select the channel which is not being used by a television broadcasting station in the area in which the equipment is to be used. On the rear panel of the VCR is the VCR channel select switch. Set the switch to the position which corresponds to the channel to be used.

ADJUSTING THE TELEVISION'S VCR CHANNEL

Varying from television to television, the VCR channel (channel 0 or 1) might be considerably out of adjustment. Use the following procedure to adjust the television's VCR channel.

- 1 Turn the television power on.
- 2 Set the television to the VCR channel. (0 or 1)
- 3 Select an active TV channel by pressing a channel button (← or →) on the VCR. If TV broadcast is not received, play back the pre-recorded tape.
- 4 Set the VTR/TV selector to the "VTR" position. "VTR" indicator will be on.
- 5 Adjust the channel tuning control on the TV (or fine tuning control) to the point at which the picture image and the audio output are best.

This is your VCR RF channel. To view video playback, always set your TV channel selector to the same channel.

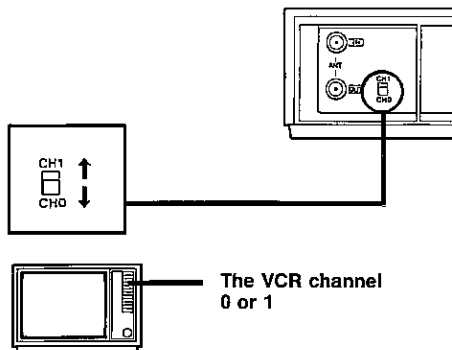

PART NAMES AND FUNCTIONS

Front

- ① EJECT button
- ② Cassette loading compartment
- ③ PICTURE sharpness control
- ④ POWER button
- ⑤ ←:Channel down/Back
→:Channel up/Next

Use these buttons to select the desired channel. To select the AV input, press one of the selector buttons until "AU" appears on the display.

- ⑥ VTR/TV selector
- ⑦ PAUSE/STILL button
During playback: still picture.
During recording: pause during which no material will be recorded.
During still playback: frame advance

- ⑧ STOP button
- ⑨ PLAYback button
- ⑩ Fast-Forward button
- ⑪ Remote control detector
- ⑫ REWInd button
- ⑬ RECord button
- ⑭ ALL CLEAR button

When pressing the **ALL CLEAR** button, the digital display will read "88:88", so that the current time and the desired times for recording programmes can be reset.

- Depress the **ALL CLEAR** button in the event that the function buttons cannot be activated.

- ⑮ SP/LP mode select button
- ⑯ Tuning controls
- ⑰ FINE TUNING/TRACKING controls

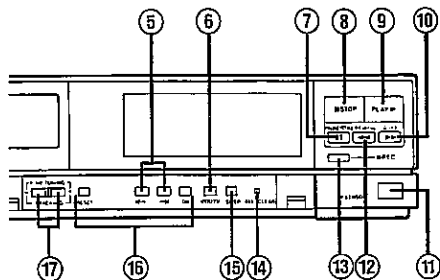
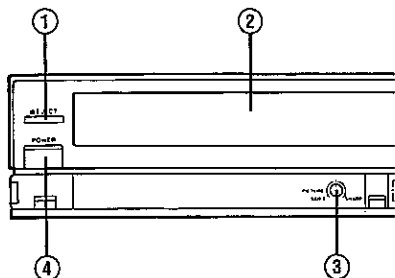

Digital Display

- ① Function indicators
- ② VTR Indicator
- ③ Cassette loading indicator
- ④ QSR indicator
- ⑤ Channel position number
- ⑥ Key lock indicator
- ⑦ Counter memory indicator
- ⑧ Clock/Timer/Counter display
- ⑨ LP mode indicator
- ⑩ Timer indicator

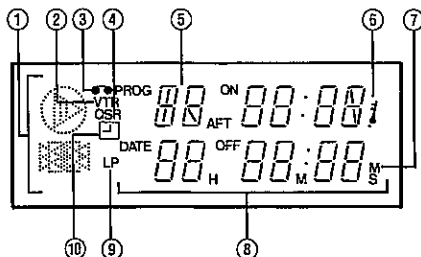

Rear

- ⑪ ANTenna INput terminal
- ⑫ AUDIO INput terminal
- ⑬ VIDEO INput terminal
- ⑭ VIDEO OUTput terminal
- ⑮ AUDIO OUTput terminal
- ⑯ STILL V-LOCK adjustment screw (for LP mode)
- ⑰ STILL V-LOCK adjustment screw (for SP mode)
- ⑱ VCR channel select switch
- ⑲ ANTenna OUTput terminal

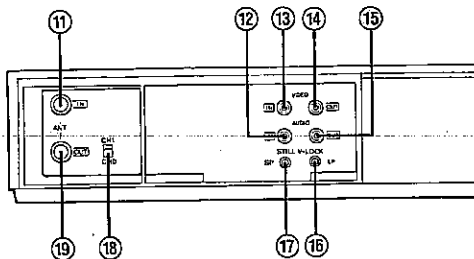

REMOTE CONTROL UNIT

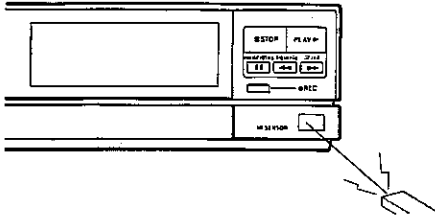

This remote control unit is a multifunction unit equipped with an LCD panel.

Each operation can be set up while looking at the remote control unit LCD panel, then transmitted to the VCR. In addition to timer programming and time adjustments, convenient special functions can also be engaged with the remote control unit. For details, see separate entries for each operation.

Normally, time and date are displayed on the remote control unit LCD panel after clock setting is completed. When programming any type of data to be sent to the VCR, the display changes according to each mode.

Notes:

- Operate the remote control unit within a range of approx. 30° from the front of the VCR.
- Operate unit within approx. 6m (20ft.) from the front of the VCR.
- Battery life under normal operating conditions is about six months. If the battery become weak, the operable distance will decrease; when this occurs, replace the batteries.
- If the remote control unit is not to be used for a long period of time, remove the batteries.
- If the battery is removed, timer programmes and other memorized material are erased.

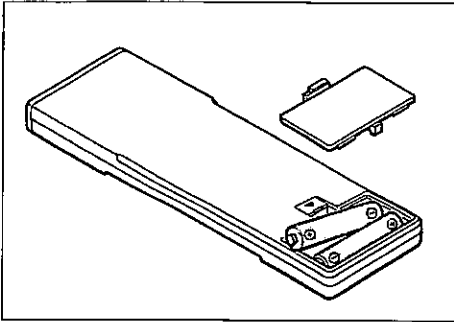

BATTERY INSERTION

1. Open the lid.
2. Insert 2"AA(IEC R6)"1.5 volt batteries (sold separately) as indicated by the (+) and (-) signs.
3. Replace the lid.

- ① **CLOCK mode indicator**
- ② **PROG**ramme mode indicator
- ③ **DATE** mode indicator
- ④ **VTR/TV** selector
- ⑤ **POWER** button
- ⑥ **PROG**ramme set
- ⑦ **Programme CHECK**
- ⑧ **CLOCK** set
- ⑨ **Programme CANCEL**
- ⑩ **SP/LP** select button
- ⑪ **Auto TRACK**ing button
- ⑫ **REW**ind button
- ⑬ **REC**ord buttons
To record, press both of these buttons.
- ⑭ **MARK** index
- ⑮ **Index/Go to SEARCH**
- ⑯ **SPECIAL** code
- ⑰ **Search BLANK** area
- ⑱ **Tape REMAIN**
- ⑲ **Switchable display**
Channel position
Special code (SP)
Index search (Id)
Go to search (To)
External input mode (AU)
- ⑳ **Switchable display**
Clock
Timer on-time
Index number
Go to time
Special code number
- ㉑ **Remote function indicator**
- ㉒ **LP** mode indicator
- ㉓ **Switchable display**
Date
Timer off-time
- ㉔ **Tuner MONITOR**
- ㉕ **Programme TRANS**fer
- ㉖ **Numeric** buttons
- ㉗ **AV** select button (0/AV)
To select the external input mode, press this button.
- ㉘ **←**:Channel down/Back
→:Channel up/Next
- ㉙ **PLAY**back button
- ㉚ **Fast-Forward** button
- ㉛ **STOP** button
- ㉜ **PAUSE/STILL** button
- ㉝ **SLOW** motion
- ㉞ **Counter MEMORY** button
- ㉟ **Counter RESET** button

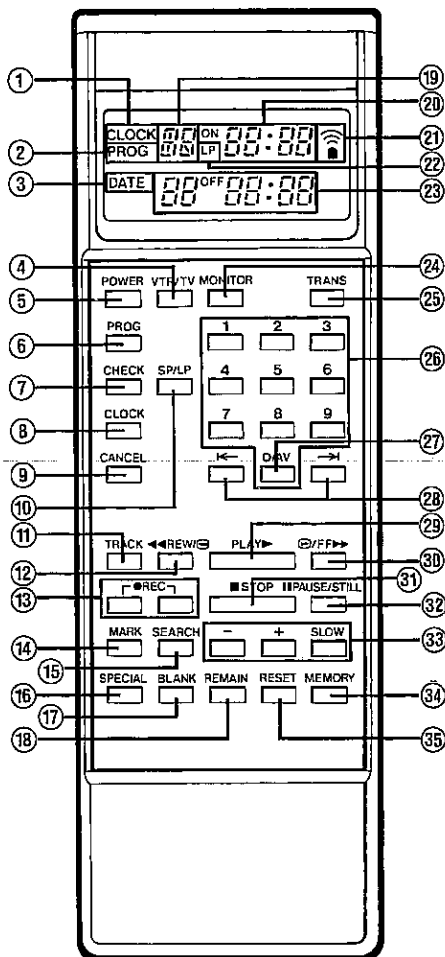

CLOCK SETTING

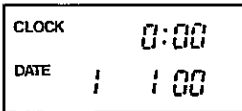

1

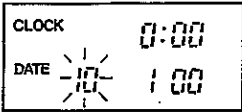

2

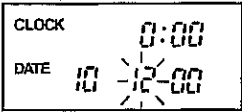

3

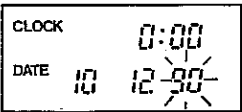

4

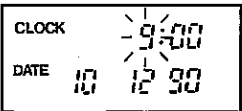

5

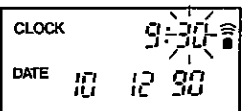

6

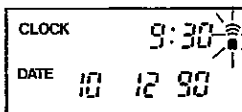

7

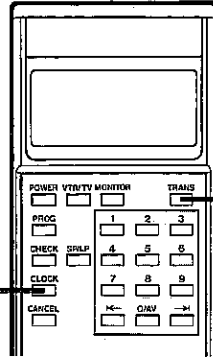

- Clock setting takes place with the remote control unit.
- Clock setting can be changed by pressing the ← or → button until the desired figure flashes. Then input correct number.
- When a one digit number is going to be set, press "0/AV" first and then the desired number (ex: In case of 9: press "0/AV" and then "9".)

Example: 9:30 December 10, 1990

- 1 Press the **CLOCK** button, then press the → button once.
 - 2 Set the **DAY** with numeric buttons.
Example: DAY = 10
 - 3 Set the **MONTH** with numeric buttons.
Example: MONTH = 12
 - 4 Set the **YEAR** with numeric buttons.
Example: YEAR = 90
 - 5 Set the **HOUR** with numeric buttons.
Example: HOUR = 09
 - 6 Set the **MINUTE** with numeric buttons.
Example: MINUTE = 30
 - 7 While the remote function indicator (RFI) blinks, press the **TRANS** button.
- Whenever the remote function indicator (RFI) flashes, it indicates that the setting can be transferred to the VCR.

Second Counter Adjustment

On the VCR side, the seconds counter starts from "00" seconds immediately upon transmission from the remote control unit. Adjust the seconds counter accurately for co-ordination between MINUTE adjustment and transmission period timing.

TUNING CONTROL ADJUSTMENTS

This VCR has a built-in tuner which can be preset for up to 39 TV channels. To preset channels, proceed as follows:

Check before starting

- Set the channel selector of your TV receiver to the VCR operating channel. (channel 0 or 1)

Example: To preset UHF channel "23" to channel position number "12".

- 1** Set the **VTR/TV** selector to the "VTR" position. "VTR" indicator will be on.
- 2** Press the tuning **PRESET** button.
- 3** Select the desired channel position number (**Example: "12"**) by pressing the **←** or **→** button. Then press the **OK** button.
- 4** Select "**L**", "**H**" or "**U**" (**Example: "U"**) by pressing the **←** or **→** button. Then press the **OK** button.
 - When the **←** or **→** button is pressed, the character "**L**", "**H**", "**U**", or "**S**" (skip) will be sequentially displayed as a band indicator.

Band Indicator	Channel Range
L	0—5
H	5A—11
U	28—69
S	Skip function (See page 13.)

- 5** When the **←** or **→** button is pressed, a channel being used for broadcast will be automatically found.

Note: Since the lowest position of the band becomes the tuning point when a band has been selected, at the beginning push the **→** button and then start searching for the channel.

When a channel is located by channel searching, the same search stops and the channel indicator changes from blinking to steady illumination, and at the same time, "**AFT**" indicator illuminates. Check the TV screen to confirm that the located channel is the channel you want and, if it is, proceed to step 6. If it is not, repeat step 5.

- 6** Press the **OK** button, and the station selected is memorized. When presetting another channel position number display, repeat steps 3 to 6 by following the same procedure.

- 7** When the **PRESET** button is pressed, the display will return to the normal display.

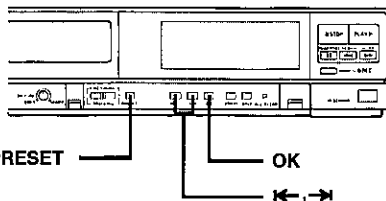

2

3

4

5

6

7

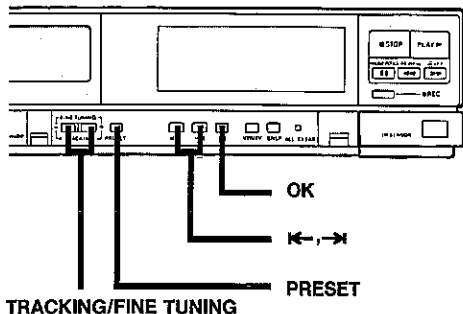

CHANNEL FINE TUNING

For the preset channels, the received picture is automatically optimised in the AFT on condition, but it may happen that reception can be somewhat improved, if signals are weak or if the channel is disturbed by interference, by fine tuning with the AFT off.

- 1 Press the **PRESET** button.
- 2 Press the **←** or **→** button to select the unsatisfactory channel.
- 3 Press the **FINE TUNING/TRACKING** (**-** or **+**) button until obtaining the best possible picture and sound. When the **FINE TUNING/TRACKING** button is pressed the AFT indicator is turned off, and the fine tuning can then be made.
- 4 Then press the **PRESET** button.
Note: To reset AFT from "off" to "on", press the **PRESET** button once, select the channel position number, press the **OK** button, and once again press the **PRESET** button.
 If the AFT isn't reset to "on" despite performing the above operation, preset it once again (see page 12).

SKIP FUNCTION

This video recorder can memorise up to 39 TV channels. If not all preset positions are used, the skip function lets you skip over the unused positions.

Example: To skip channel position number "10".

- 1 Press the **PRESET** button.
- 2 Press the **←** or **→** button to select the channel position number (**Example:** "10") to be skipped.
Then press the **OK** button.
- 3 Press the **←** or **→** button until the band indicator shows "S".
Note: "S" denotes SKIP.
 To cancel the SKIP mode, press the **←** or **→** button once again to select the band to be received, and then preset once again (see page 12).
- 4 Press the **OK** button.
- 5 When the **PRESET** button is pressed, the display will return to the normal display.

CASSETTE LOADING AND UNLOADING

LOADING

When a video cassette is inserted, it will be loaded automatically and the cassette indicator will illuminate.

Auto play

The VCR will play back a tape automatically when a video cassette is inserted whose erasure-prevention tab has been removed.

UNLOADING

The video cassette will be unloaded when the **EJECT** button is pressed.

Off power eject

A video cassette will be ejected when the **EJECT** button is pressed even with VCR is in stand-by condition.

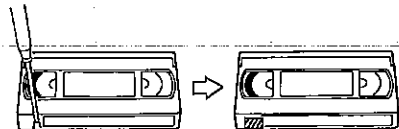
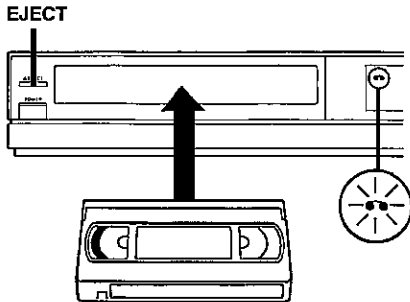

CAUTION:

Do not put your hand or other objects behind the cassette door because of the risk of injury or an accident.

Be sure to keep small children away from the VCR.

ERASURE-PREVENTION TAB

If the erasure-prevention tab on the back of the video cassette is removed, the cassette can not be recorded. This tab is designed to prevent the accidental erasure of recorded material. (The tab should be snapped off at its base, and removed completely.)

To record onto the same cassette again, place two layers of adhesive tape over the space where the tab was, so as to cover the space completely.

COUNTER MEMORY

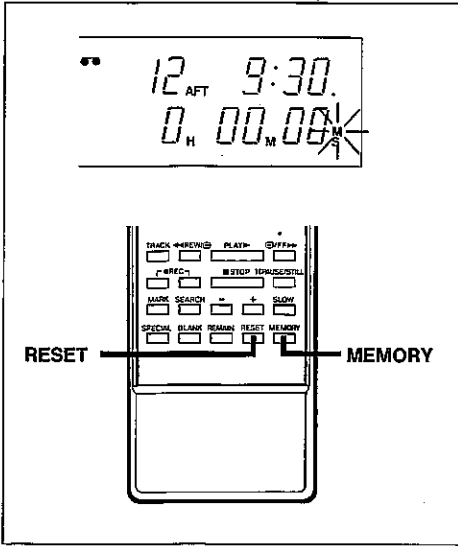

This convenient feature for finding the beginning of a specific recording etc., is made possible by the "Linear Time Counter" that indicates the tape run time in seconds.

- When the Counter indicator is displaying remainder amount of tape, press **REMAIN** button. Then the indicator will display counter.
- Whenever you load a cassette tape, the counter will be reset to "0 H 00 M 00 s".
- The counter operates using control signals which are recorded on the tape, hence if you playback a tape which has nothing recorded on it, the counter will not operate.

- 1** Press the **RESET** and **MEMORY** buttons before starting recording or playback. The zero point of the counter is now memorized and the memory indicator "M" will illuminate.
- 2** When the **REW** button is pressed at the end of recording, or playback, tape will be rewound automatically to the memorized position and then stops.
 - When rewinding further back from position "0 H 00 M 00 s" the counter shows figures beginning with "2".
 - The tape stops at the memorized position even with fast forward.

RECORDING TELEVISION BROADCASTS

Check before starting

- Set the channel selector of your TV receiver to VCR operating channel (channel 0 or 1).

- 1 Insert a video cassette.
- 2 Set the **VTR/TV** selector to the **VTR** position. "VTR" indicator will be on.
- 3 Select your desired tape speed using the **SP/LP** button. When you select the LP mode, the LP mode indicator will illuminate on the display.
- 4 Press the numeric buttons or **←**, **→** button for the channel (channel position) to be recorded.
Example: "23"
- 5 Press the **REC** button.

- Video recording starts. This is the normal video recording procedure.

QUICK START RECORDING (QSR) TIMER

Timer Recording is simple.

- 1 Press the **REC** button to start recording.
- 2 Then press the **REC** button again. The "OFF--:" indication will start flashing on the VCR display. Within 10 seconds, use the **REC** button to set the recording end time. You can set the recording end time in units of 30 minutes.

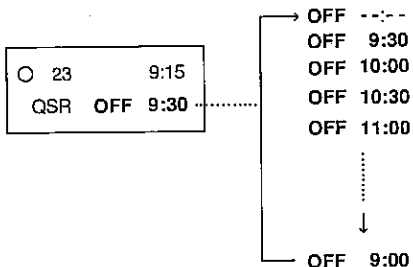

Check/change

When the **REC** button is pressed "during QSR recording, the QSR ending time will be displayed for 10 seconds. The QSR ending time can be changed by pressing the **REC** button during this 10 seconds period.

- 6 To stop the recording, press the **STOP** button.

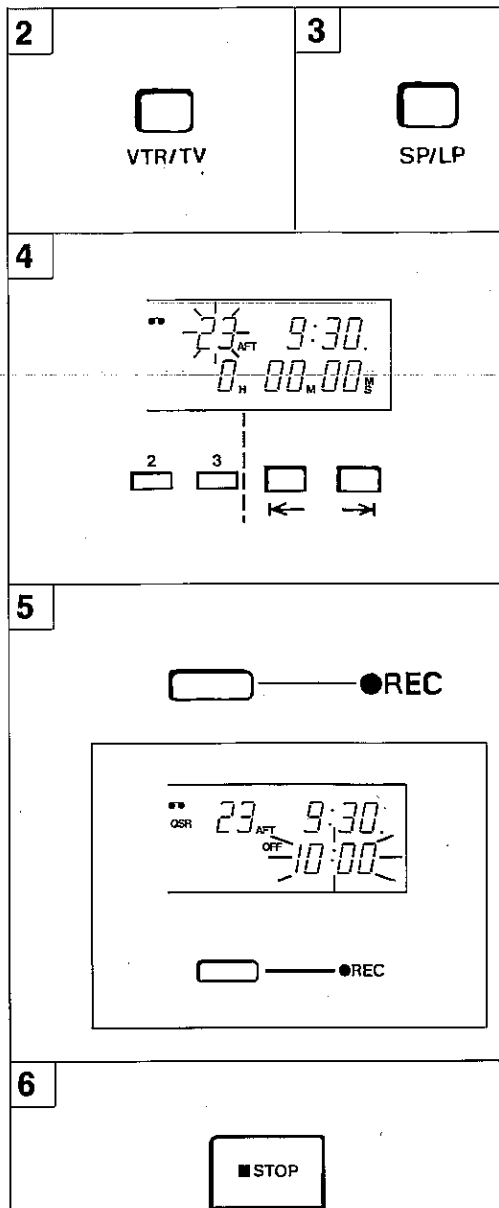
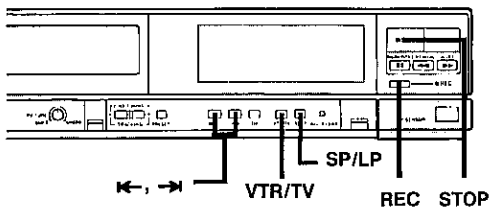

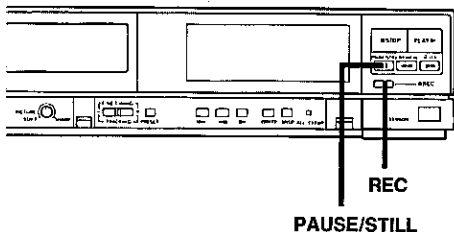

OTHER RECORDING POSSIBILITIES

If you wish to avoid recording unwanted material

- 1 During recording, press the **PAUSE/STILL** button. The TV picture will not be recorded.
- 2 Press the **PAUSE/STILL** button or **REC** button, and the recording will resume.
Note: If REC PAUSE mode continues for about five minutes, the VCR will automatically go into the stop mode in order to protect the tape from damage.

Recording one programme while watching another

- 1 Start recording the desired TV programme, selected on the VCR.
- 2 Set the **VTR/TV** selector to the "TV" position. "VTR" indicator will be off.
- 3 Select any alternative programme position on your TV receiver.

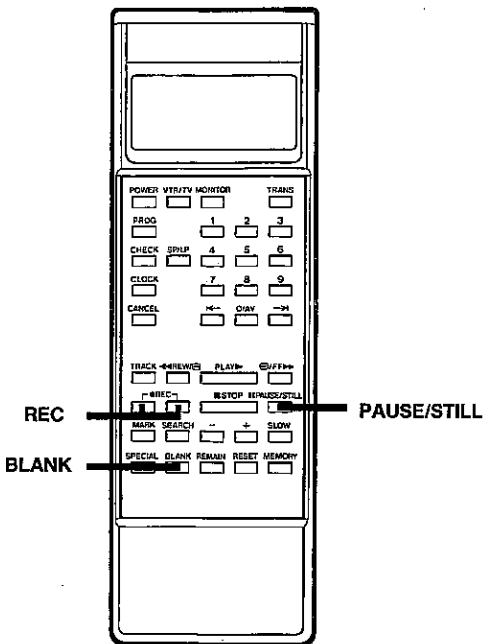

USING THE BLANK SEARCH FUNCTION

The blank search function automatically searches for the next blank (unrecorded) portion of the tape, and stops the VCR at that position. This is convenient when you want to continue recording at the end of a previous recording.

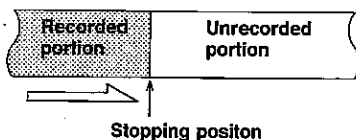

- Press the **BLANK** button. The VCR will locate the next blank portion on the tape, and stop at that position.
- If no blank portions are found all the way to the end of the tape, the VCR will switch directions and start searching toward the start of the tape.
- If no blank portions are found, the VCR will go all the way to the start of the tape and then stop.
- During the search, the words "TO End" will be shown in the VCR display.

Notes:

- The stopping position may vary slightly. Play back a few seconds of the tape to make sure it is at the position you want.
- This function may also stop the VCR during slight pauses (unrecorded portions) between taped programmes.

CAMERA RECORDING/ CAMCORDER DUBBING

Check before starting

- Set the channel selector of your TV receiver to VCR operating channel (channel 0 or 1).
- Insert the video cassette.
- Press the **0/AV** button on the handset to obtain an **AU** on the programme position display, or use the **←** or **→** buttons on the VCR. The "AV" input status is the one in which "**AU**" is displayed in the channel position number display.
- Select your desired tape speed using the **SP/LP** button.

- 1** Turn on the power of the video camera and adjust the focus, white balance, etc.. For Camcorder dubbing select **PLAY** on the Camcorder.
- 2** Press the **REC** button on the VCR or handset.
- 3** To stop the recording, press the **STOP** button on the VCR or handset.

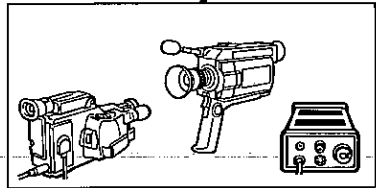
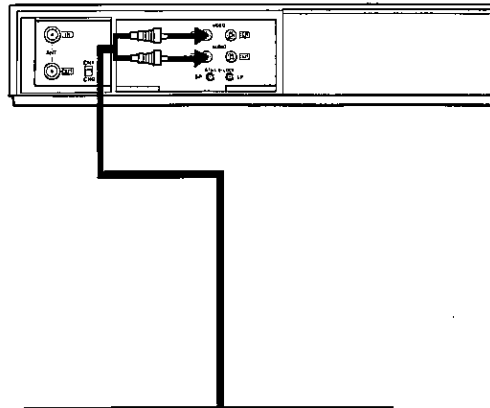

DUBBING

You can monitor a programme while dubbing by connecting a TV to the VCR **B**'s **ANT OUT** terminal.

- 1** Connect VCR **A** and VCR **B**.
- 2** Insert the pre-recorded tape into the VCR **A**.
- 3** Insert the blank video cassette into the VCR **B**.
- 4** Set VCR **B** to the "AV (external)" input condition.
- 5** Press the **PLAY** button on the VCR **A**, and then press the **REC** button on the VCR **B**.

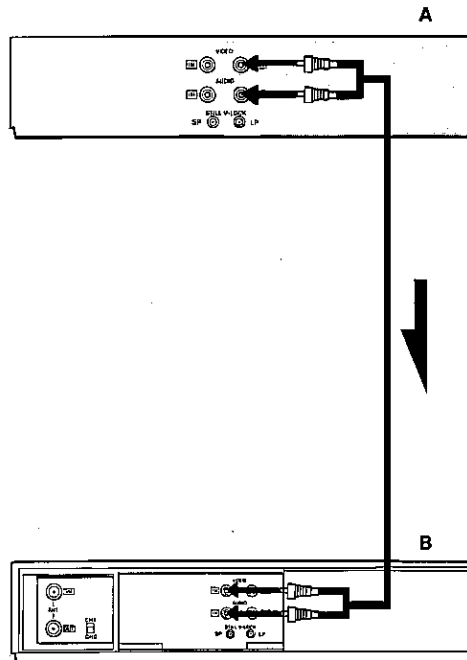

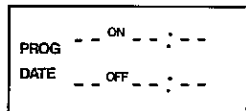

PROG



2

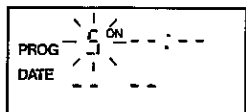

O/AV

5



3

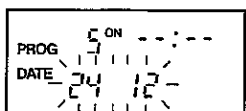

2

4

1

2

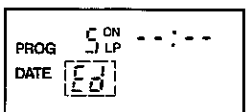

O/AV

O/AV

SP/LP



4

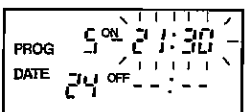

2

1

3

O/AV



5

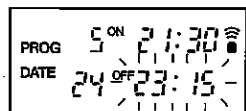

2

3

1

5



6

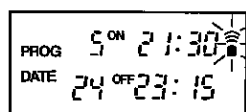

TRANS



TIMER RECORDING

Timer recording enables you to carry out unattended video recording of television broadcasts at preset times. The following data must be entered to set the timer programme:

- Channel position number
- Day and month on which the recording is to be made
- Time at which timer recording is to start (on-time)
- Time at which timer recording is to stop (off-time)

Use the remote control unit to set the timer. Before setting the timer programme, be sure that the present time shown in the display is correct.

Example: Reserve channel 5 from 21:30 to 23:15 on December 24, 1990.

- Insert a video cassette (with erasure-prevention tab).

1 Press the **PROG** button.

2 Set the **CHANNEL(position number)** with numeric buttons. **Example: Channel 5**

3 Set the **DAY** with numeric buttons. **Example: 24**
Set the **MONTH** with numeric buttons. **Example: 12**

Everyday recording

To record everyday, press the "O/AV" numeric button twice. "Ed" appears on the display.

Tape speed selection

Press the **SP/LP** button to set the desired tape speed. If you select the LP mode, the **LP** indicator turns on.

4 Set the **ON-HOUR** with numeric buttons. **Example: 21**
Set the **ON-MINUTE** with numeric buttons. **Example: 30**

5 Set the **OFF-HOUR** with numeric buttons. **Example: 23**
Set the **OFF-MINUTE** with numeric buttons. **Example: 15**

- 6 Press the **TRANS** button.
- When programme data is sent to the VCR, the VCR automatically enters the timer standby mode and the Timer indicator () lights up.
 - The VCR memory can store up to 6 programmes.

ERASURE OF REMOTE CONTROL UNIT PROGRAMME DATA

Since the data for only 4 programmes can be stored in the remote control unit, if more than 4 programmes have been timer programmed, unnecessary programmes must be cancelled and setting must be performed once again.

- 1 Press the **PROG** button to display on the remote control unit LCD panel the programme data to be cancelled.
- 2 Press the **CANCEL** button.

CONFIRMATION OF REMOTE CONTROL UNIT PROGRAMME DATA

- 1 Each time the **PROG** button is pressed, programme data stored in the remote control unit is shown sequentially on the remote control unit LCD panel.
 - When the programme memory of the remote control unit is available, if the **PROG** button is pressed, the initial programme set mode (data input stand-by) is entered.
 - To confirm day/month, press the **→** button twice during confirmation.

REVISION OF REMOTE CONTROL UNIT PROGRAMME DATA



- 1 Press the **PROG** button to display on the remote control unit LCD panel the programme data to be revised.
- 2 Press the **→** (or **←**) button until the number to be changed is blinking.
- 3 Press the numeric buttons and correct the number.
- 4 After revisions are completed, press the **PROG** button.

CONFIRMING, REVISING OR CANCELLING PROGRAMME DATA SENT TO THE VCR

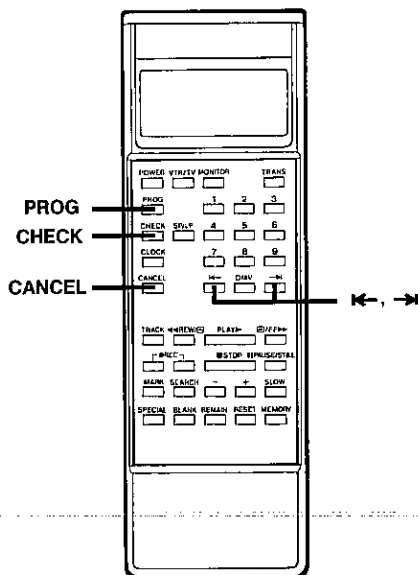
Press the **CHECK** button on the remote control unit while watching the VCR display. The programme data for each programme in memory is displayed in sequence. The procedure for revising and cancelling programme data is the same as that for memorizing programmes. The first step in memorizing a programme in the remote control unit is normally to press the **PROG** button. However, to access a programme directly as you watch the VCR display, press the **CHECK** button first.



NOTES ON TIMER SETTING

- Data for a maximum of 4 programmes can be stored in the remote control unit. Hence transmission can be performed after 4 programmes have been set in steps 1 to 5. The procedure is to call out in sequence the programmes set with the **PROG** button and transmit them to the VCR by the **TRANS** button.
- The timer indicator () will flash to inform you if no video cassette is loaded.
- The timer indicator () will flash 5 minutes before the starting time of each of the set programmes is reached.
- If an error occurs in the transmission of programme data from the remote control unit, "ER(error)" is shown on the VCR display. In this case, set the infrared emitter component of the remote control unit properly in front of the VCR remote control unit detector and transmit once again.
- When the VCR's programme memory is full, the VCR displays "FULL".
- If programme setting is abandoned midway, the programme is automatically cancelled.
- The year is not displayed in the programme data of the remote control unit.
- If the same time is set for the recording start time and recording stop time, timer recording will be set to take place for 24 hours. Please note that, when a tape is inserted, recording will continue to the end of the tape.

By using the timer in this unit, you can record a source from an external audio/video unit.

At the step for setting the channel position number (for ordinary programming), cause "AU" to appear in the channel position number display and enter the external input mode into the memory.

To select the external input mode, enter "00" by pressing the **0/AV** button on the remote control unit twice.

Note: You cannot turn the power to the external unit ON or OFF.

Programme priority

- If several recordings have been timer-programmed with overlapping recording times, then the recording with the earliest start time will be recorded first.
- If the start time for a second recording is reached before the programmed stop time for the first recording, the first recording will continue to the original stop time and the second recording will start after the first recording has finished.

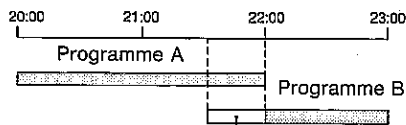

This portion will not be recorded.

- If several recordings have been programmed for the same start time on the same day, the programmed recording that was first entered has priority.

Remaining time display with timer notice

The total time of timer programming and the amount of time remaining on the loaded tape are shown automatically on the VCR digital display. After timer programming to the VCR side has been completed, the following data are displayed for about 5 seconds. The same data are displayed after programme confirmation.

Total time of timer programme

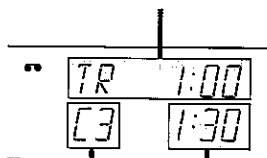

Cassette type
(see page 24)

Time remaining on tape

Notes:

- Everyday recording timer for one day is included in the total time of timer recording.
- If the time on remaining tape is less than the total time of the timer programme, the "TR" indicator blinks to warn that all the programmes cannot be recorded on the tape.
- The remaining tape indication in this system is a value which has been converted into "SP" mode, even if a reservation is made in the "LP" mode.

PLAYBACK

Check before starting

- Set the channel of your TV receiver to VCR operating channel (channel 0 or 1).

- 1 Insert the video cassette.
- 2 Press the **PLAY** button.
- 3 To stop the playback, press the **STOP** button.
 - To rewind the tape, press the **REW** button.
 - To advance (fast-forward) the tape, press the **FF** button.

FORWARD SEARCH

- Press the **FF** button during playback for fastforward operation. The picture can be viewed while the tape is advanced at a fast speed.
- Normal playback will resume as the **PLAY** button is pressed.

REVERSE SEARCH

- Press the **REW** button during playback for rewind operation. The picture can be viewed while the tape is rewound at a fast speed.
- Normal playback will resume as the **PLAY** button is pressed.

You can perform fast forward, forward search, rewind, and reverse search operations by simply pressing the **FF** and **REW** buttons on this VCR. For example, each time the **FF** button is pressed, the VCR will change from fast forward to forward search, or vice-versa. This is extremely useful when searching for a particular section of a programme.

STILL PICTURE

- Press the **PAUSE/STILL** button during playback. A still picture can be viewed.
- Normal playback will resume when the **PLAY** button is pressed.

FRAME ADVANCE

- Press the **PAUSE/STILL** button during still playback. The picture will advance frame by frame. One press advances one frame.
- Normal playback will resume when the **PLAY** button is pressed.

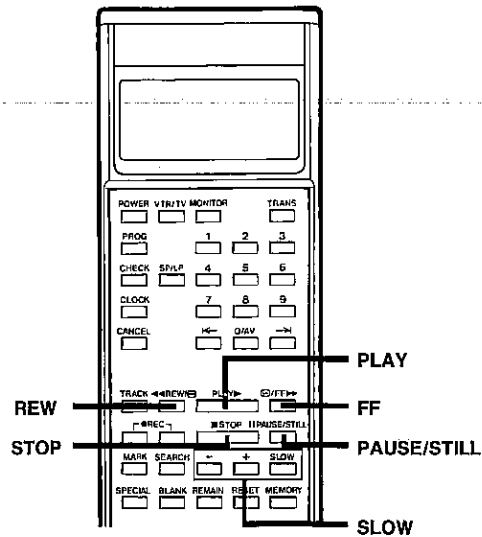
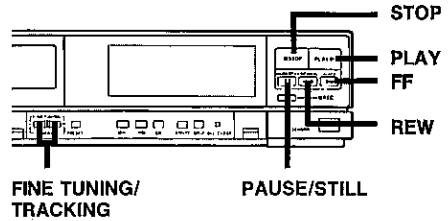

SIMPLE SLOW MOTION

- Press the **SLOW** button during playback or during still picture. The picture can be viewed while the tape is advanced at approximately 1/10 slow-motion. If the - button or + button of the remote control unit is pressed, the tape speed can be variable from 1/5 to 1/25 of normal speed.
- Normal playback will resume as the **PLAY** button is pressed.

TRACKING ADJUSTMENT

If the playback picture shows noise interference, adjust the **FINE TUNING/TRACKING** (-, +) control buttons to minimize the noise.

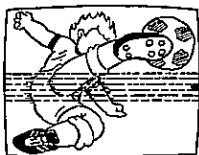

Noise interference

Tracking condition will be displayed as follows:

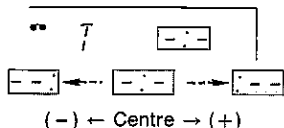

AUTO TRACKING ADJUSTMENT

When the **TRACK** button of the remote control unit is pressed, adjustment to the optimum point occurs automatically.

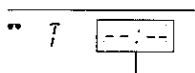

Auto tracking display

Note:

- If you wish to return the tracking adjustment to its original "centre position" after having changed it, press the **FINE TUNING/TRACKING** "-" and "+" buttons simultaneously.
- If you use a poorly recorded tape, the noise level may fail to reach the optimum point. In this case, perform manual adjustment.

PICTURE SHARPNESS ADJUSTMENT

Set the **PICTURE** sharpness control for the picture quality that suits your tastes.

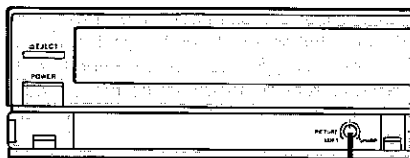

PICTURE

TV MONITOR FUNCTION

This function lets you view a TV programme during video playback.

- Press and hold the **MONITOR** button during video playback. The TV programme on the channel that was most recently selected will be shown on the TV screen for as long as the button is held.
- You can also monitor other external input sources if you wish. To do so, select AV input.

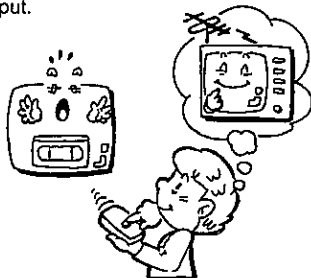

Notes:

- During the special playback (forward search, reverse search, still picture and frame advance) the picture may contain some "noise" or vibration. But this is not a malfunction.
- If still picture playback is continued for about five minutes, the VCR will automatically change to stop mode in order to protect the tape from damage.
- If still picture moves up and down, turn the **STILL V-LOCK** adjustment screw. Turn the "SP" screw or the "LP" screw depending on the tape speed. If VCR's **STILL V-LOCK** adjustment cannot remove this movement, also adjust the V-HOLD control of the TV receiver.

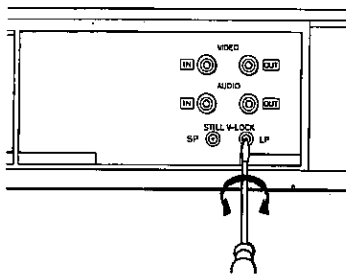

TAPE REMAINDER

This convenient function enables you to determine at a glance the duration of remaining tape.

TO CONFIRM DURING PLAYBACK, RECORDING etc.

- When the **REMAIN** button pressed once, the cassette type and duration of remaining tape are indicated by digital display.

Notes:

- Press the **REMAIN** button after the tape has been running for about 20 to 30 seconds at standard tape speed (normal playback or recording). This time interval is essential for calculating the duration of remaining tape.
- The correct cassette type is sometimes not indicated because of slight variation in tape length. When this occurs, input the correct cassette number.

TO CONFIRM WHEN UNIT IS

- Press the **REMAIN** button once.

The VCR operates for several seconds to calculate the duration of remaining tape, and then indicates by digital display the cassette type and the remaining tape duration.

- Press the **REMAIN** button once again to restore the original display.

IMPORTANT NOTICE STOPPED

Automatic calculation and display of remaining tape duration can only be done with cassettes marked 'O' as shown blow. When using a differente type of cassette, after the **REMAIN** button has been depressed, input "CASSETTE NUMBER" with numeric buttons and press the **→** button while the cassette type indicator ("C3") is flashing (about 5 seconds).

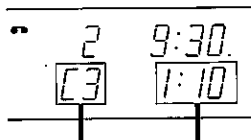

Cassette type indicator Remaining of tape

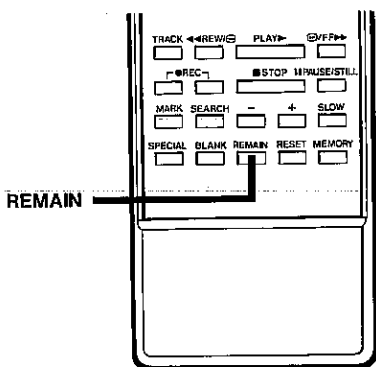

Auto ID	Cassette	Cassette number	Cassette type display	
			SP	LP
○	E-30	30	03	C1
○	E-60	60	C1	C2
○	E-90	90	09	C3
○	E-120	120	C2	C4
○	E-150	150	15	C5
○	E-180	180	C3	C6
	E-195	195	19	38
	E-210	210	21	C7
○	E-240	240	C4	C8
	E-300	300	C5	C0

INDEX SEARCH FUNCTION

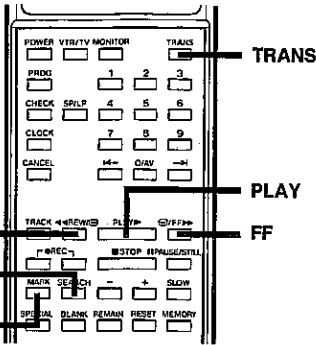

This convenient function enables you to use the index signal recorded at the beginning of each programme to easily select a desired programme. Data is programmed at the LCD panel of the remote control unit and transmitted to the VCR.

RECORDING OF INDEX SIGNAL

- This index signal is recorded automatically at the beginning of each recording. While the index is being recorded, "Id" is shown on the VCR digital display.
- The **MARK** button can be used for manual index recording during record or playback.

Note: Index signal cannot be recorded after REC PAUSE.

INDEX OF INDEX SIGNAL

This feature enables each programmes with index signals recorded to be played back for 5 seconds consecutively during search.

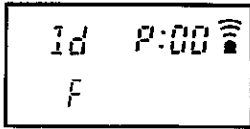

1

SEARCH

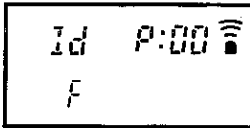

2

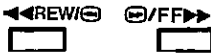

3

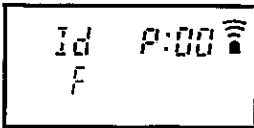

TRANS

4



PLAY

1. Press the **SEARCH** button **once** during the STOP or PLAY mode.

2. Press the **FF** or **REW** button depending upon the scanning direction. The "FF" indication on the LCD panel indicates fast forward, and the "F" indication indicates rewind.

The "F" indication appears first, so this step can be skipped for scanning in the fast forward mode.

3. Press the **TRANS** button.

FF or REW starts and each time an index signal is found, the tape is played back for about 5 seconds.

4. Press the **PLAY** button when the desired programme is seen.

To return the LCD panel to the initial display, press the **SEARCH** button.

INDEX SEARCH

This feature enables automatic search for and playback of a programme whose INDEX number is known.

- 1 Press the **SEARCH** button **once** during STOP or PLAY mode.
- 2 Press the number using the numeric buttons before or after the present one you wish to watch. **Example: 15**
 - Any index number up to "99" can be designated.
 - Press the **CANCEL** button when revising.
- 3 Designate the direction of search by pressing the **FF** button or the **REW** button. The "F" indication on the LCD panel indicates the fast-forward direction, and the "r" indication indicates the rewind direction. This step can be skipped for search in the fast-forward direction.
- 4 Press the **TRANS** button.
 - FF or REW starts and when the designated index number is found, playback starts automatically.

Notes:

- If you insert the index signal in the Playback mode, the audio will not be heard while the index signal is being recorded.
- In the playback mode you cannot insert an index signal on a video cassette which does not have an erasure-prevention tab or at non-recorded part of the tape.
- If you record or erase an index signal to or from a tape recorded using another VCR, the video programme at that point may be disturbed or it may be impossible to search it.

To return the LCD panel to the initial display, press the **SEARCH** button.

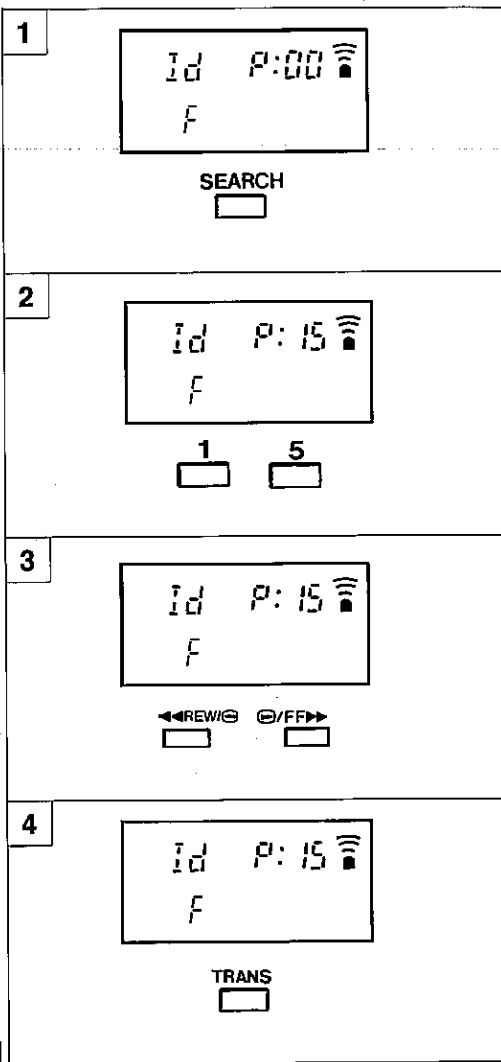
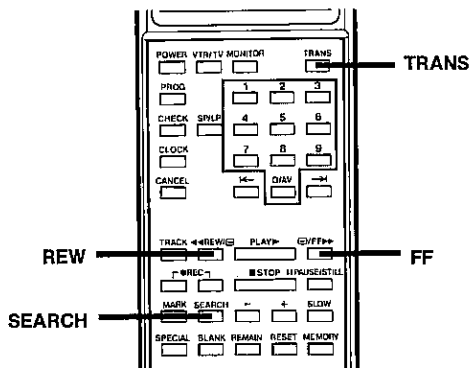

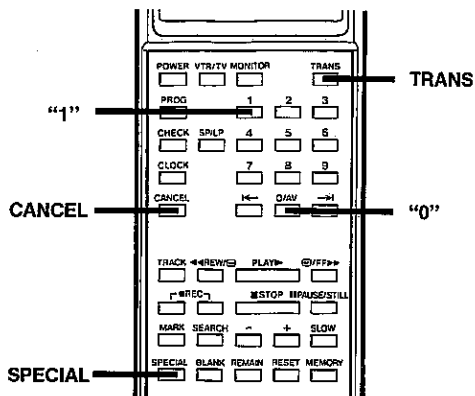

TO ERASE THE INDEX SIGNAL

Carry out the following procedures to erase a recorded index signal you want to erase.

- 1 Playback the programme having the index signal you want to erase.
- 2 Press the **SPECIAL** button.
- 3 Input the special code "10" for index signal erasure with the numeric button.
 - Press the **CANCEL** button when revising.
- 4 Press the **TRANS** button.
 - The VCR will start searching backwards toward the beginning of the programme and erase the index signal automatically.
 - "E" is shown on the VCR display while index signal is being erased.

Note:

Insert the index signal at least five minutes apart from each other. If these signals are too close together, the unit will sometimes fail to operate normally during erase operation.

To return the LCD panel to the initial display, press the **SPECIAL** button.

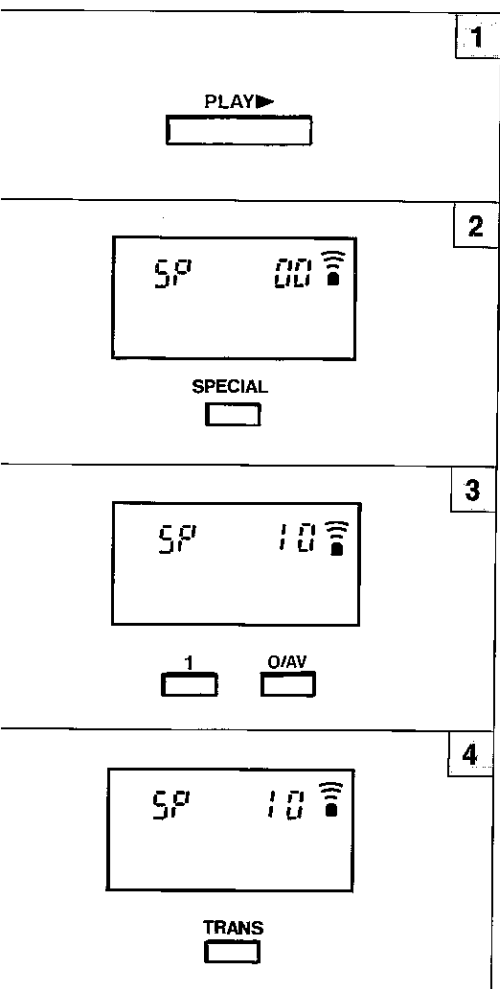

GO TO SEARCH FUNCTION

This feature enables forward and reverse search with reference to tape playing time.

- 1 Press the **SEARCH** button **twice** during **STOP** or **PLAY** mode.
- 2 Input the time difference between the desired scene and present tape position, using the numeric buttons.
Example: 1 hour 20 minutes
 Press the **CANCEL** button when revising.

- 3 Designate the direction of search by pressing the **FF** button or the **REW** button. The "F" indication on the LCD panel indicates the fast-forward direction, and the "r" indication indicates the rewind direction. This step can be skipped for search in the fast-forward direction.

- 4 Press the **TRANS** button.
 Tape will advance at fast speed to the desired scene and then starts playback.
Note: The error between the designated time and the counter reading is about ± 30 seconds.

To return the LCD panel to the initial display, press the **SEARCH** button.

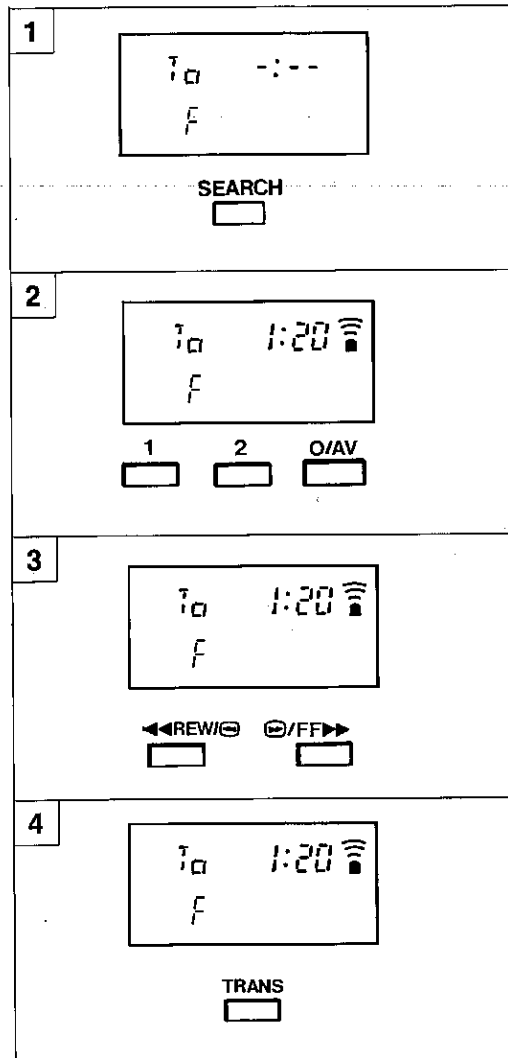
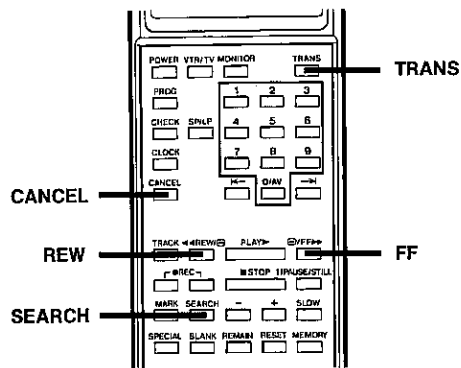

SPECIAL CODE FUNCTION

For your convenience, this VCR has various special functions using SPECIAL CODE.

- 1 Press the **SPECIAL** button.
- 2 Input 2-digit SPECIAL CODE with numeric button.
Example "91" (ENDLESS PLAY)
 Press the **CANCEL** button when revising.
- 3 Press the **TRANS** button.

Upon completion of the aforementioned fundamental operations, special functions can be implemented by inputting each special code through step 2.

"01" - DIMMER: Changes digital display brightness.

- 1 With power on, transmit SPECIAL CODE "01"
- 2 To restore original brightness, transmit "01" once again.

"02" - KEY LOCK: Prevents all operation of the VCR.

- 1 Transmit SPECIAL CODE "02". When the KEY LOCK engaged, the "L" in indicator is shown on the display.
- 2 To cancel the lock function, retransmit "02" once again.

Please note that when you transmit SPECIAL CODE 02 (KEY LOCK) to the VCR, all VCR control buttons become inoperative. It is recommended that you turn off the VCR power before transmitting SPECIAL CODE 02.

"10" - INDEX ERASE: Erases the index signal. (see page 27)

"91"-ENDLESS PLAY: Play back the tape repeatedly from beginning to end (from tape start to "0 H 00 M 00 S" in case of counter memory.

- 1 Insert the cassette tape, and transmit SPECIAL CODE "91". Playback starts once the tape has been rewound to the beginning.

To return the LCD panel to the initial display, press the **SPECIAL** button.

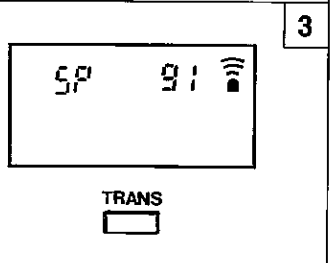
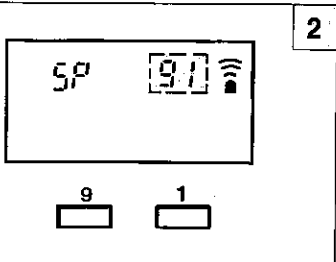
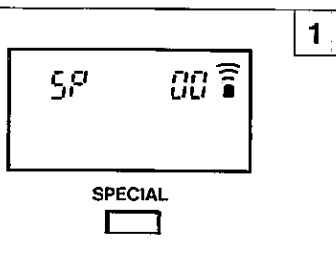
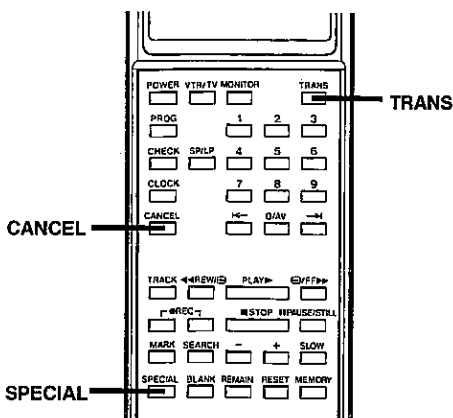

REPAIRS

This VCR is a precision instrument and treated with care, will provide years of satisfactory performance. However, in the event of difficulty, the owner is advised not to attempt to make repairs or open the cabinet. Servicing should always be referred to your servicing dealer or SANYO Authorized Warranty Station.

TROUBLESHOOTING

This VCR is highly sophisticated. It is shipped from the factory after having been checked and adjusted under the most rigid quality control and inspection system. Should problems occur, check the following points.

Symptom	Check points
No power	<ul style="list-style-type: none">• The power cord is disconnected.
No off the air programmes received	<ul style="list-style-type: none">• Are the connections between your VCR and TV correct?• The TV channel selector has not been set to VCR operating channel (Channel 0 or 1).
Off the air reception on the VCR is poor	
No recording	<ul style="list-style-type: none">• The erasure-prevention tab on the cassette has been removed.
Timer recording is not possible	<ul style="list-style-type: none">• The starting day and time have not been set correctly.• The clock time is not set correctly.• There has been a power interruption.
Playback picture does not possible	<ul style="list-style-type: none">• The TV channel selector has not been set to VCR operating channel (channel 0 or 1).
Interference on playback picture	<ul style="list-style-type: none">• Adjust the tracking control.• Dust and dirt on video heads. <p>Take the VCR to an Authorized Service Station or dealer.</p>

SPECIFICATIONS

General

Video format:	VHS PAL
Television system:	CCIR: 625 lines, PAL colour signals
Recording system:	Rotary two head helicalscan system
Tape speed:	23.39 mm/sec
Recording time:	240 minutes with E-240 cassette
Tuner input:	VHF: 0 — 11 UHF: 28 — 69
RF converter:	Built-in VHF converter
Converter output:	On channel 0 or 1
Timer indication:	24 hour indication
Power failure backup:	Approx. one hour
Timer recording:	1 year 6 programmes with every day function
Power requirement:	AC 240.V. \pm 10%, 50 Hz
Dimensions (W x H x D):	420 x 79 x 320mm
Weight:	Approx. 6 kg
Power consumption:	30 W.

Electrical characteristics

Video input level:	0.5 - 2.0 Vp-p
Video input impedance:	75 \pm 5 ohms
Video output level:	1.0 \pm 0.2 Vp-p
Video output impedance:	75 \pm 5 ohms
Video S/N: Luminance:	more 43 dB
Resolution: Colour:	more than 240 lines
Audio input level:	-8 dBs
Audio input impedance:	More than 50 kohms
Audio output level:	-8 dBs
Audio output impedance:	Less than 10 kohms

Remote control unit

Power requirements:	3V (2"AA (IEC R6)" size, 1.5-volt batteries)
---------------------	--

Accessories

Instruction manual	1
Antenna output cable	1
Remote control unit	1

Appearance and specifications are subject to change without notice.

1AC6P10A69600
RP4/A (0890-D-SY01)

SANYO

SANYO Electric Co., Ltd.
Printed in Japan