

SANYO

Instruction
Manual

Video cassette
recorder

VHR-D4600

VHS HQ
PAL
DIGITAL

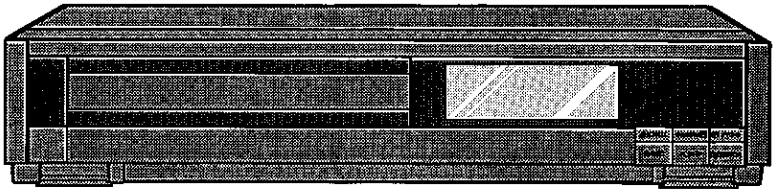
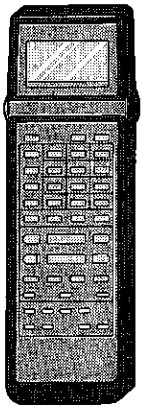

Congratulations. You are now the owner of a SANYO Digital Video Cassette Recorder. Please read these instructions before operating the VCR.



- This VCR is based on a PAL-VHS signal system. Only video cassettes bearing the **VHS** symbol can be used.
- Video cassette recorders bearing the "HQ" mark incorporate VHS high picture quality technology. Note that there is interchangeability with former VHS video cassette recorders.

CONTENTS

PRECAUTIONS	2
FEATURES	3
DIRECT POWER ON AND GO SYSTEM	3
CONNECTIONS	4
ADJUSTING THE TV RECEIVER	4
PART NAMES AND FUNCTIONS	6
REMOTE CONTROL UNIT	7
CLOCK SETTING	8
TUNING CONTROL ADJUSTMENTS	9
CASSETTE LOADING AND UNLOADING	11
RECORDING TELEVISION	
BROADCASTS	12
CAMERA RECORDING	14
DUBBING	14
PLAYBACK	15
TIMER RECORDING	17
INSERT EDITING	19
TAPE REMAINDER	20
INDEX SEARCH FUNCTION	21
GO TO SEARCH FUNCTION	23
SPECIAL CODE FUNCTION	24
DIGITAL EFFECTS	26
REPAIRS	37
TROUBLESHOOTING	37
SPECIFICATIONS	38

DEW SENSOR

When operating the VCR, always pay attention to the following.

- If the DEW indicator (□□ □□) illuminates, delay all operations until the DEW indicator goes off.
- Because condensation will form gradually, the DEW indicator may not illuminate immediately when the temperature or humidity has changed abruptly, even though dew has formed inside the VCR.
- Therefore, when operating a VCR under conditions for forming condensation such as an abrupt change of temperature or humidity, wait approximately 20 minutes until condensation is confirmed not to have formed.

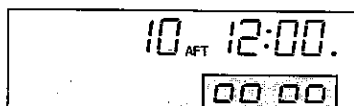

DEW indicator

PRECAUTIONS

WARNING:

This Instruction Manual has been prepared for use with products used in both Australia and New Zealand. In those places in the manual where descriptions, information, etc., differ for the two countries, both are provided and described as such, so the reader should take care to read the applicable part.

COUNTRY	TV CHANNEL
AUSTRALIA	AUST. CH—0 or CH—1
NEW ZEALAND	N.Z. CH—2 or CH—3

OPERATING PRECAUTIONS

- Removing the cabinet and touching the inside of the VCR with your hand, a screwdriver, or anything else, is not only harmful to the unit, but is also dangerous.
TO PREVENT FIRE OR SHOCK HAZARD, DO NOT EXPOSE THIS PRODUCT TO RAIN OR MOISTURE.
- The unauthorized recording of television programmes, video tapes, films and other such material may involve infringement of copyright or the rights of third parties.
- Be sure to use this VCR only in a temperature range of 5°C to 35°C and less than 85% humidity.
- This VCR is sensitive to magnetism. Do not expose to a magnetic source.
- Place the VCR on a flat, stable, level surface. Never subject it to violent shaking or any other shock or impact.
- Do not block the air vents that are provided to prevent the temperature inside the VCR from rising excessively.

The power on/off (**ON/STOP**) button of this VCR is a secondary circuit, and does not disconnect the unit from the AC power source, even if the button is in the stand-by position, as long as the power cord is connected to AC electrical outlet.

NOTE: Stand-by is the condition in which the digital display becomes dimmer and the date and time are displayed.

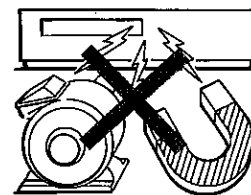
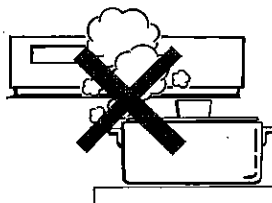
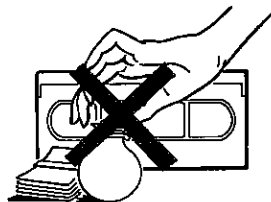
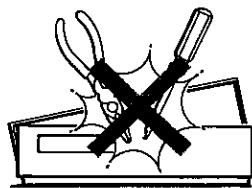

FEATURES

- VHS high quality picture technology
- 39-position voltage synthesizer tuner
- Multi-function infra-red remote control
- Built-in 1 year, 8-event timer with every day function
- QSR (Quick Start Recording) timer
- Enjoyable digital plays
- Linear time counter
- Forward and reverse picture search
- Still picture playback
- Frame advance playback
- Double (x2) speed playback
- Variable slow motion
- Lesson repeat playback
- Remaining time display with timer notice
- Special code operation
- Index/Go to search system
- Various Convenient automatic functions

DIRECT POWER ON AND GO SYSTEM

Power on

If a control button is pressed while the VCR is in stand-by, the power is supplied directly with that control button and functioning begins.

Example: If you press the PLAY button, the VCR will be turned on and start playback.

Note: This function is not provided for the REC button. This is to prevent the VCR from being easily put into a video recording condition. Normally, when only the power is being supplied, press the STOP button (⏻/■STOP).

Power off

The video recorder will be turned off if you press the STOP button (⏻/■STOP) in the stop mode.

Auto power stand-by

When STOP mode continues for five minutes, the power supply is cut off automatically.

When you want to continue with power supply at ON, perform channel select operation at the end. If the final operation selects channel, the "Auto power stand-by function" can be aborted.

This system is also active from the remote control unit.

Self power on

The power is automatically switched on as a cassette is inserted even when the VCR is in the stand-by condition.

MEP (Miss Erasure Prevention) EJECT

A video cassette will automatically be ejected if recording is attempted on a video cassette without an erasure-prevention tab.

Auto rewind

The VCR automatically rewinds the tape at the end of the tape.

Auto rewind eject

When the EJECT button is pressed while the REW button is kept depressed, the VCR will automatically eject the cassette after the tape has been rewound to the beginning or to the counter memory position ("0H 00M 00s").

Auto re-play

When the PLAY button is pressed while the REW button is kept depressed, the VCR begins playback again automatically after the tape has been rewound to the beginning or to the counter memory position (0H 00M 00s). When controlling the VCR with the remote control unit, press the REW-PLAY button on the unit.

Auto play

The VCR will playback a tape automatically when a video cassette is inserted whose erasure-prevention tab has been removed.

Auto eject

When a video cassette without an erasure-prevention tab is played to the end of the tape, the tape will be automatically rewound and then the cassette will be ejected.

Off power eject

A video cassette will be ejected when the EJECT button is pressed even with the VCR in stand-by condition.

Auto-timer stand-by

If timer setting is completed, VCR's power is automatically switched off and is in the timer stand-by mode.

CONNECTIONS

ANTENNA CONNECTION

- Unplug the antenna cable from your TV receiver and reconnect to the terminal marked "ANT IN" on the VCR.
- Connect the antenna cable supplied as an accessory of the VCR to the "ANT OUT" terminal on the VCR. Connect the other end of this antenna cable to the TV receiver.
- Insert the plug of the power cord into the wall socket.

AV-CONNECTION (Lead not supplied)

- Connect the AUDIO/VIDEO terminal on the VCR to the AV terminal on the TV receiver.
- The advantage of this connection is a superior quality of picture and sound during playback.

AV CONTROL FUNCTION

- If connections are made to an AV control compatible TV, the TV's input can be controlled at the VCR. This means that when the VCR's PLAY button is pressed, the TV input is switched automatically so that the TV functions as a video monitor.

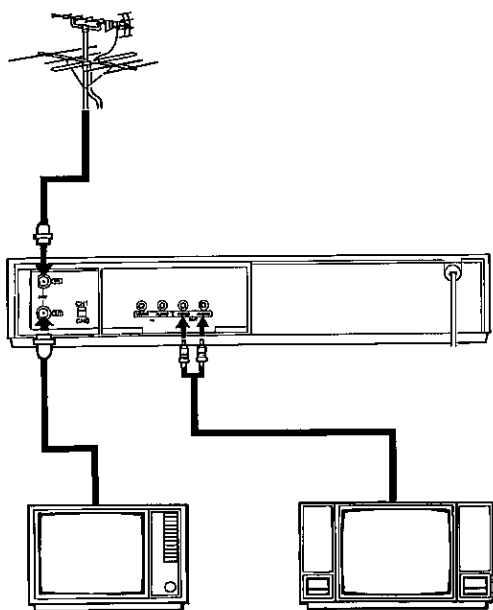

ADJUSTING THE TV RECEIVER

The VCR channel for this equipment is either channel 0 or 1 ... for AUSTRALIA (channel 2 or 3 ... for NEW ZEALAND). Select the channel which is not being used by a television broadcasting station in the area in which the equipment is to be used. On the rear panel of the VCR is the VCR channel select switch. Set the switch to the position which corresponds to the channel to be used.

ADJUSTING THE TELEVISION'S VCR CHANNEL

Varying from television to television, the VCR channel (channel 0 or 1 ... for AUSTRALIA, channel 2 or 3 ... for NEW ZEALAND) might be considerably out of adjustment. Use the following procedure to adjust the television's VCR channel.

- 1 Turn the television power on.
- 2 Set the television to the VCR Channel.

The VCR channel
AUSTRALIA.....channel 0 or 1
NEW ZEALAND.....channel 2 or 3

AUSTRALIA

CH1 ↑
 CH0 ↓

NEW ZEALAND

CH3 ↑
 CH2 ↓

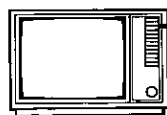
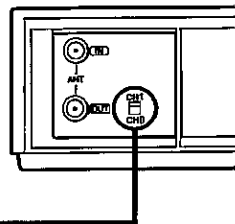

The VCR channel
 AUSTRALIA0 or 1
 NEW ZEALAND.....2 or 3

- 3 Select an active TV channel by pressing a CHANNEL Button (up or down) on the VCR. If TV broadcast is not received, play back the pre-recorded tape.
- 4 Set the VTR/TV selector to the "VTR" position. "VTR" indicator will be on.
- 5 Adjust the channel tuning control on the TV (or fine tuning control) to the point at which the picture image and the audio output are best.

This is your VCR RF channel. To view video playback, always set your TV channel selector to the same channel.

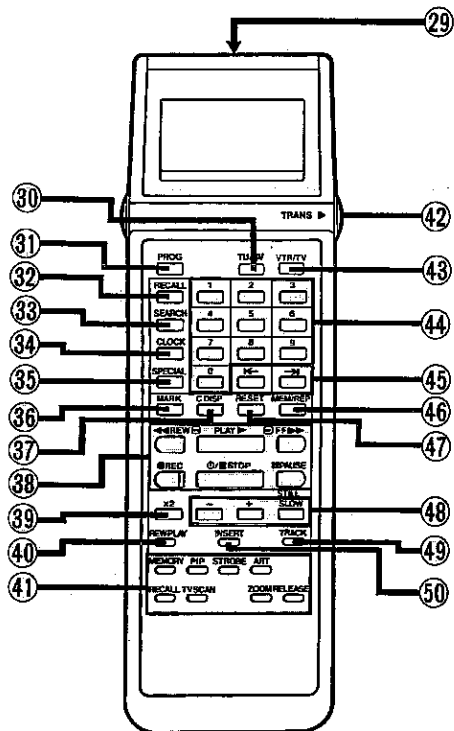
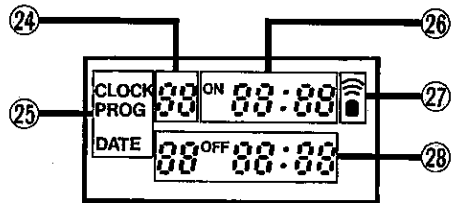
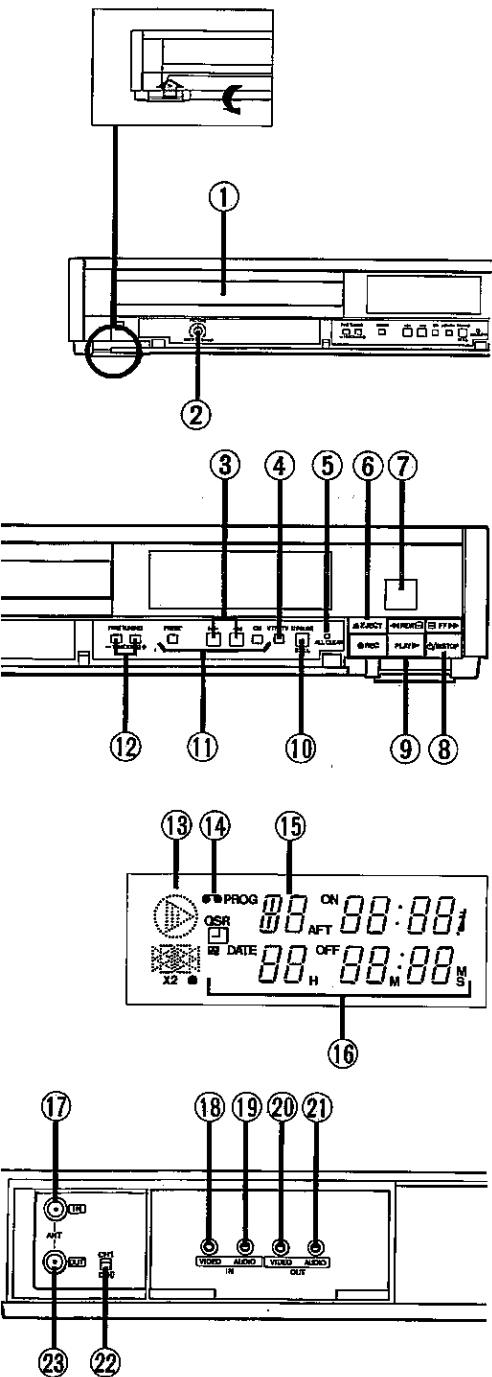

PART NAMES AND FUNCTIONS

Front

- ① **Cassette loading compartment**
- ② **PICTURE sharpness control**
- ③ **Channel selector buttons**
Use these buttons to select the desired channel. To select the AV input, press one of the selector buttons until "AU" appears on the display.
- ④ **VTR/TV selector**
- ⑤ **ALL CLEAR button**
- ⑥ **EJECT button**
- ⑦ **Remote control detector**
- ⑧ **Power on-off/STOP button (O/STOP)**
The VCR will be turned off if you press the STOP button in the STOP mode.
If this button is pressed when the VCR is in a power stand-by condition, the VCR will go ON.
- ⑨ **Main functions**
- ⑩ **PAUSE/STILL button**
During playback: still picture.
During recording: pause during which no material will be recorded.
During still playback: advance the frame.
- ⑪ **Tuning controls**
- ⑫ **FINE TUNING/TRACKING controls**

Digital display

- ⑬ **Function indicators**
- ⑭ **Cassette loading indicator**
- ⑮ **Channel position number**
- ⑯ **Clock/Timer/Counter display**

Rear

- ⑰ **ANTenna INput terminal**
- ⑱ **VIDEO IN terminal**
- ⑲ **AUDIO IN terminal**
- ⑳ **VIDEO OUT terminal**
- ㉑ **AUDIO OUT terminal**
- ㉒ **VCR channel select switch**
- ㉓ **ANTenna OUTput terminal**

Remote Control Unit

- ㉔ **Channel/position number**
- ㉕ **Mode Indicator**
- ㉖ **Clock display**
- ㉗ **Remote function indicator**
- ㉘ **Date display**
- ㉙ **Infrared ray emitter component**
To transmit operations to the VCR, place this unit in front of the VCR and operate it.
- ㉚ **TU/AV Input select**
- ㉛ **PROGRAM set**
- ㉜ **Program RECALL**
- ㉝ **Index/Go to SEARCH**
- ㉞ **CLOCK set**
- ㉟ **SPECIAL code operation**
- ㊱ **MARK Index**
- ㊲ **Change DISPLAY**
- ㊳ **Main functions**
- ㊴ **x2 (double speed playback)**
- ㊵ **Auto REWInd PLAYback**
- ㊶ **Digital play functions**
- ㊷ **Program TRANSfer**
- ㊸ **VTR/TV selector**
- ㊹ **Numeric buttons**
- ㊺ **←: Back/Channel down
→: Next/Channel up**
- ㊻ **Counter MEMORY/Lesson REPEAT**
- ㊼ **Counter RESET**
- ㊽ **SLOW (x 1/5 — x 1/25)**
- ㊾ **Auto TRACKing button**
- ㊿ **INSERT button**

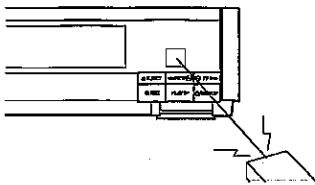

REMOTE CONTROL UNIT

This remote control unit is a multifunctional unit equipped with an LCD panel.

Each operation can be set up while looking at the remote control unit LCD panel, then transmitted to the VCR. In addition to timer programming and time adjustments, convenient special functions can also be engaged with the remote control unit. For details, see separate entries for each operation.

Normally, time and data are displayed on the remote control unit LCD panel after clock setting is completed. When programming any type of data to be sent to the VCR, the display changes according to each mode.

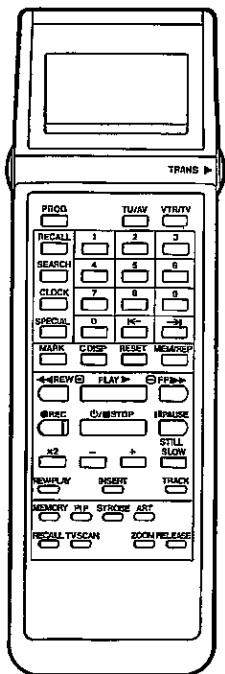

BATTERY INSERTION

1. Open the lid.
2. Insert 2 "AA (IEC R6)" 1.5 volt batteries (sold separately) as indicated by the (+) and (-) signs.
3. Replace the lid.

Notes:

- Operate the remote control unit within a range of approx. 30' from the front of VCR.
- Operate unit within approx. 6 m (20 ft.) from the front of VCR.
- The battery life under normal operating conditions is about six month. If the batteries become weak, the operable distance will decrease; when this occurs, replace the batteries.
- If the remote control unit is not to be used for a long period of time, remove the batteries.
- If the batteries are removed, timer programmes and other memorized material are erased.

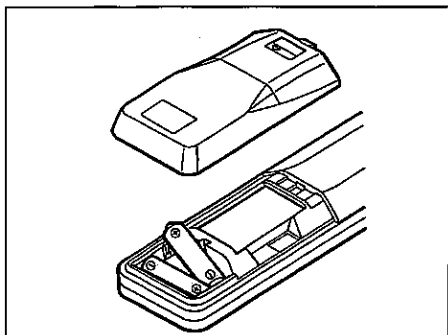

CLOCK SETTING

- Clock setting can be changed by pressing the **←** or **→** button until the desired figure flashes. Then input correct number.
- When a one digit number is going to be set, press "0" first and then the desired number. (ex.: In case of 9: press "0" and then "9".)

Example: 9:30 December 10, 1988

1 Press the **CLOCK** button, then press the **→** button once.

2 Set the **DAY** with numeric button.
Example: DAY = 10

3 Set the **MONTH** with numeric button.
Example: MONTH = 12

4 Set the **YEAR** with numeric button.
Example: YEAR = 88

5 Set the **HOUR** with numeric button.
Example: HOUR = 09

6 Set the **MINUTE** with numeric button.
Example: MINUTE = 30

7 While the remote function indicator (📶) flashes, press the **TRANS** button.

- Whenever the remote function indicator (📶) flashes, it indicates that the setting can be transferred to the VCR.

Seconds Counter Adjustment

On the VCR side, the seconds counter starts from "00" seconds immediately upon transmission from the remote control unit. Adjust the seconds counter accurately for coordination between MINUTE adjustment and transmission period timing.

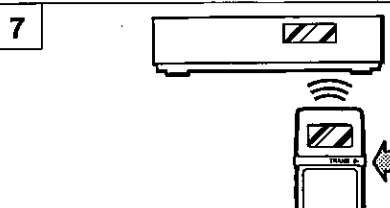
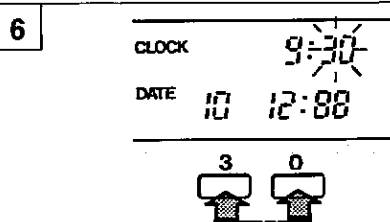
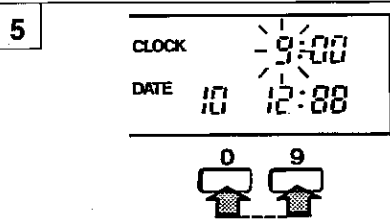
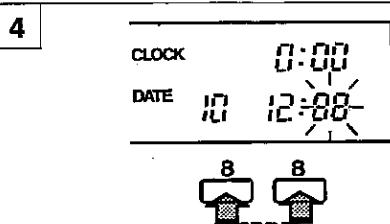
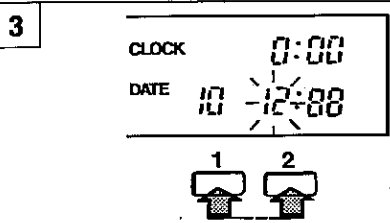
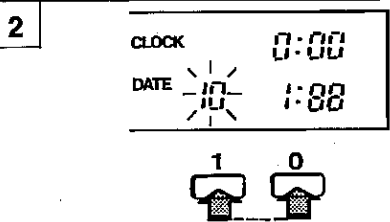
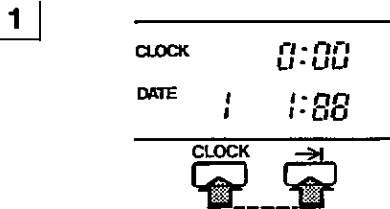
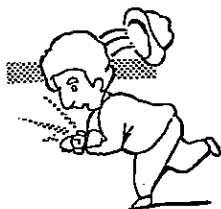

TUNING CONTROL ADJUSTMENTS

Check before starting

- Set the channel selector of your TV receiver to the VCR operating channel (channel 0 or 1 for AUSTRALIA, channel 2 or 3 for NEW ZEALAND)

Example: To preset UHF channel "23" to channel position number "12".

- Set the VTR/TV selector to the "VTR" position. ("VTR" indicator will be on.)
 - Press the tuning PRESET button.
 - Select the desired channel position number (**Example:** "12") by pressing the \leftarrow or \rightarrow button. Then press the OK button.
 - Select "L", "H" or "U" (**Example:** U) by pressing the \leftarrow or \rightarrow button. Then press the OK button.
- When the \leftarrow or \rightarrow button is pressed, the character "L", "H", "U" or "S" (skip) will be sequentially displayed as a band indicator.

Band Indicator	Channel Range	
	For AUSTRALIA	For NEW ZEALAND
L	0-5	1-3
H	5A-11	4-11
U	21-65	21-65
S	Skip Function (See page 10)	

- When the \leftarrow or \rightarrow button is pressed, a channel being used for broadcast will be automatically found.
Note: Since the lowest position of the band becomes the tuning point when a band has been selected, at the beginning please push the \rightarrow button and then start searching for the channel.
 When a channel is located by channel searching, the same search stops and the channel indicator changes from blinking to steady illumination, and at the same time, "AFT" indicator illuminates. Check the TV screen to confirm that the located channel is the channel you want and, if it is, proceed to step 6. If it is not, repeat step 5.

- Press the OK button, and the station selected is memorized.
 When presetting another channel position number display, repeat steps 3 to 6 by following the same procedure.

- When the PRESET button is pressed, the display will return to the normal display.

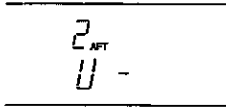
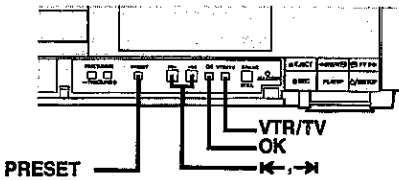

2

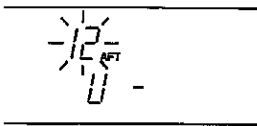

3

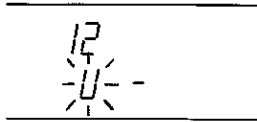

4

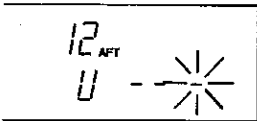

5

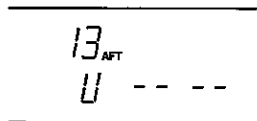

6

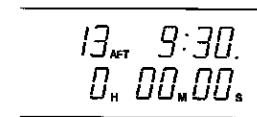

7



9

SKIP FUNCTION

The skip function gives you the possibility to jump the unused channels.

Example: To skip channel position number "10".

- 1 Press the PRESET button.
- 2 Press the \leftarrow or \rightarrow button to select the channel position number (**Example:** "10") to be skipped. Then press the OK button.
- 3 Press the \leftarrow or \rightarrow button until the band indicator shows "S".
Note: "S" denotes SKIP.
To cancel the SKIP mode, press the \leftarrow or \rightarrow button once again to select the band to be received, and then preset once again (see page 9).

- 4 Press the OK button.
- 5 When the PRESET button is pressed, the display will return to the normal display.

CHANNEL FINE TUNING

For the preset channels, the received picture is automatically optimized in the AFT on condition, but it may happen that reception can be somewhat improved, if signals are weak or if the channel is disturbed by interference, by fine tuning with the AFT off.

- 1 Press the \leftarrow or \rightarrow button to select the unsatisfactory channel.
- 2 Press the PRESET button.
- 3 Press the FINE TUNING/TRACKING (- or +) button until the best possible picture and sound are obtained. When the FINE TUNING/TRACKING button is pressed the AFT indicator is turned off, and the fine tuning can then be made.
- 4 Then press the PRESET button.
Note: To reset AFT from "off" to "on", press the PRESET button once, select the channel position number, press the OK button, and once again press the PRESET button.
If the AFT isn't reset to "on" despite performing the above operation, preset it once again (see page 9).

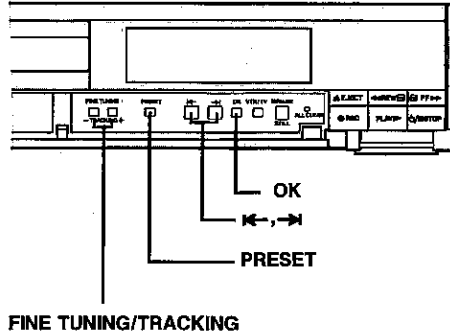

CASSETTE LOADING AND UNLOADING

LOADING

When a video cassette is inserted, it will be loaded automatically and the cassette indicator will illuminate.

UNLOADING

The video cassette will be unloaded when the EJECT button is pressed.

ERASURE-PREVENTION TAB

If the erasure-prevention tab on the back of the video cassette is removed, it cannot be recorded. This tab is designed to prevent the accidental erasure of recorded material. (The tab should be snapped off at its base, and removed completely.)

To record onto the same cassette again, place two layers of adhesive tape over the space where the tab was, so as to cover the space completely.

COUNTER MEMORY

This convenient feature for finding the beginning of a specific recording etc., is made possible by the "Linear Timer Counter" that indicates the tape run time in seconds.

- When the Counter Indicator is displaying remainder amount of tape, press the C DISP (Change Display) button. Then the Indicator will display counter.
- Whenever you load a cassette tape, the counter will be reset to "0H 00M 00s".
- The counter operates using control signals which are recorded on the tape, hence if you playback a tape which has nothing recorded on it, the counter will not operate.

- 1** Press the RESET and MEM/REP buttons before starting recording or playback. The zero point of the counter is now memorized and the memory indicator "M" will illuminate.

Note: If you press the MEM/REP button during playback, the unit will enter the Lesson Repeat mode (page 16).

- 2** When the REW button is pressed at the end of recording, or playback, tape will be re-wound automatically to the memorized position and then stop.
When rewinding further back from position "0H 00M 00s" the counter shows figures beginning with "...".
The tape stops at the memorized position even with fast forward.

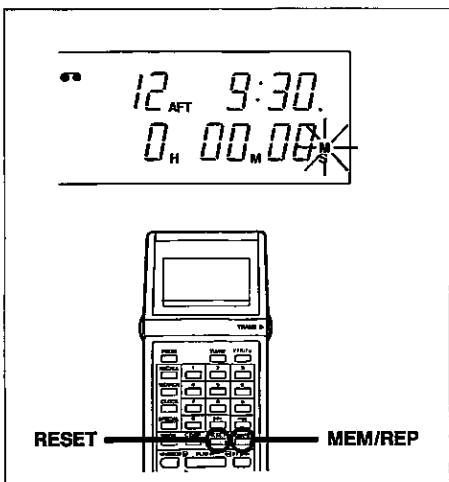
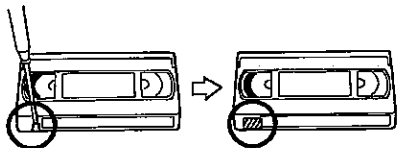
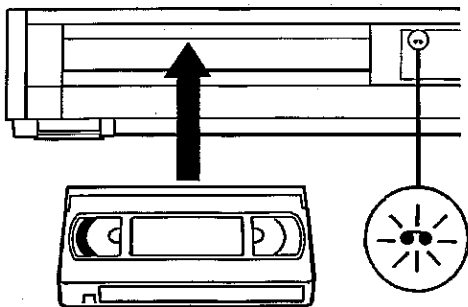

RECORDING TELEVISION BROADCASTS

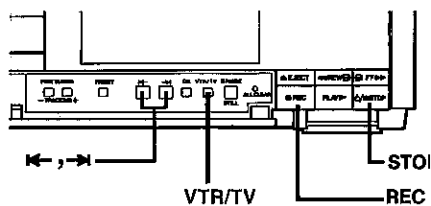

Check before starting

- Set the channel selector of your TV receiver to VCR operating channel (channel 0 or 1 for AUSTRALIA, channel 2 or 3 for NEW ZEALAND).

- 1 Insert a video cassette.
- 2 Set the VTR/TV selector to the "VTR" position ("VTR" indicator will be on.)
- 3 Press the numeric buttons or **←**, **→** button for the channel (channel position) to be recorded.
Example: "23"
- 4 Press the REC button.

Video recording starts. This is the normal video recording procedure.

Normally, after the REC button has been pressed, the **QUICK START RECORDING (QSR) TIMER** setting mode is entered within 10 seconds. If you want to set the video record finish time during this interval, a finish time (example: 10:45) can be set. Even if video recording continues for more than 10 seconds, finish time can be set in a similar fashion by pressing the REC button. Setting can be performed with any of the following buttons.

Numeric button: Direct setting by 10-key can be done.

REC button: Setting can be done in 30-minute increments each time this button is pressed.

→ button: Forwards by one-minute increment.

← button: Returns by one-minute increment.

Check/change

When the REC button is pressed during QSR recording, QSR ending time will be displayed for 10 seconds. The QSR ending time can be changed by pressing the Numeric buttons or REC or **←**, **→** buttons during this 10 seconds period.

- 5 To stop the recording, press the STOP button.

1

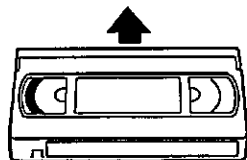

2

VTR/TV



3

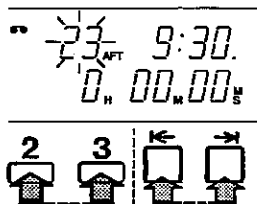

4

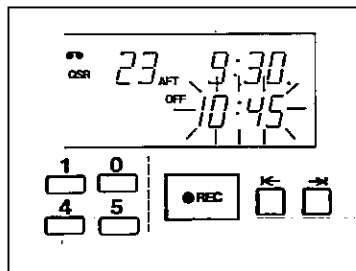

5



CAMERA RECORDING

Check before starting

- Set the channel selector of your TV receiver to VCR operating channel (channel 0 or 1 for AUSTRALIA, channel 2 or 3 for NEW ZEALAND).
- Set the VTR/TV selector to the "VTR" position ("VTR" indicator will be on.)
- Insert the video cassette.
- "AV" input status is set with the TU/AV button or the ←, → button. The "AV" input status is the one in which "AV" is displayed in the channel position number display.

- 1 Turn on the power of the video camera and adjust the focus, white balance, etc..
- 2 Press the REC button on the VCR.
- 3 To stop the recording, press the STOP button on the VCR.

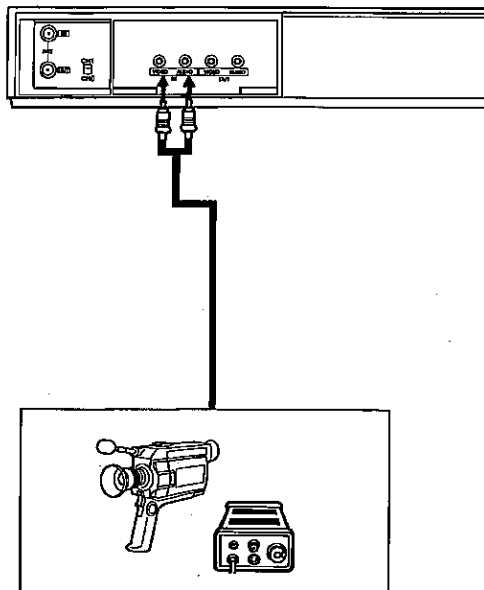

DUBBING

You can monitor a programme while dubbing by connecting a TV to the VCR 2's ANT OUT terminal.

- 1 Connect VCR 1 and VCR 2.
- 2 Insert the pre-recorded tape into the VCR 1.
- 3 Insert the blank video cassette into the VCR 2.
- 4 "AV" input status is set at the VCR with the TU/AV button or the ←, → button.
- 5 Press the PLAY button on the VCR 1, and then press the REC button on the VCR 2.

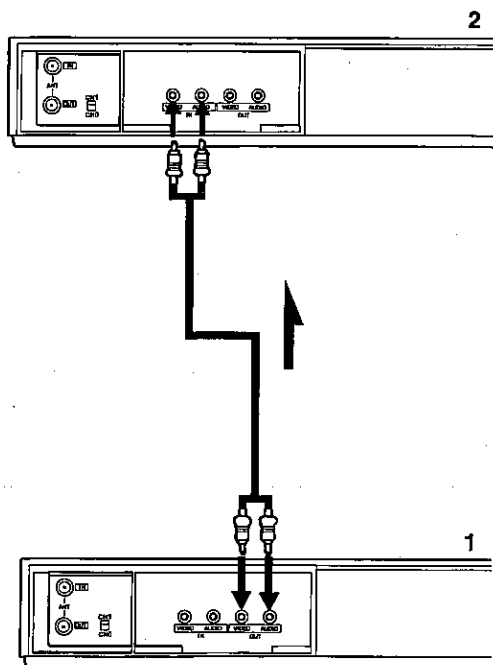

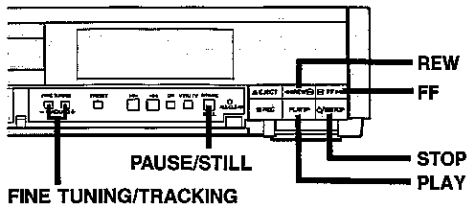

PLAYBACK

Check before starting

- Set the TV channel to VCR operating channel (channel 0 or 1 for AUSTRALIA, channel 2 or 3 for NEW ZEALAND).

- 1 Insert the video cassette.
- 2 Press the PLAY button.
- 3 To stop the playback, press the STOP button.
 - To rewind the tape, press the REW button.
 - To advance (fast-forward) the tape, press the FF button.

FORWARD SEARCH

- Press the FF button during playback or fast-forward operation. The picture can be viewed while the tape is advanced at a fast speed.
- Normal playback will resume as the PLAY button is pressed.

REVERSE SEARCH

- Press the REW button during playback or rewind operation. The picture can be viewed while the tape is rewound at a fast speed.
- Normal playback will resume as the PLAY button is pressed.

You can perform fast forward, forward search, rewind, and reverse search operations by simply pressing the FF and REW buttons on this VCR. For example, each time the FF button is pressed, the VCR will change from fast forward to forward search, or vice-versa. This is extremely useful when searching for a particular screen.

STILL PICTURE

- Press the PAUSE/STILL button during playback. A still picture can be viewed.
- Normal playback will resume as the PLAY button is pressed.

FRAME ADVANCE

- Press the PAUSE/STILL button during still playback. Playback picture will advance frame by frame. One pressing advances one frame.
- Normal playback will resume as the PLAY button is pressed.

TRACKING ADJUSTMENT (MANUAL)

If the playback picture shows "noise" interference, adjust the FINE TUNING/TRACKING (-, +) control buttons to minimize the "noise".



"Noise" interference

Tracking condition will be displayed as follows:

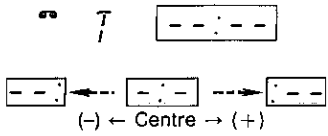

AUTO TRACKING ADJUSTMENT

When the TRACK button of the remote control unit is pressed, adjustment to the optimum point occurs automatically.

Note:

If you use a poorly recorded tape, the noise level may fail to reach the optimum point. In this case, perform manual adjustment.

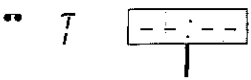

Auto tracking display

PICTURE SHARPNESS ADJUSTMENT

Set the PICTURE sharpness control for the picture quality that suits your tastes.

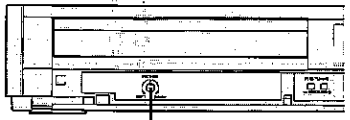

PICTURE

DOUBLE SPEED PLAYBACK

- Press the x2 button of remote control unit during playback. The double speed picture can be viewed.
- Normal playback will resume as PLAY button is pressed.

SLOW MOTION

- Press the SLOW button during playback or during still picture. The picture can be viewed while the tape is advanced at approximately 1/10 slow-motion. If - button or + button of remote control unit is pressed, the tape speed can be variable from 1/5 to 1/25 of normal speed.
- Normal playback will resume when the PLAY button is pressed.

LESSON REPEAT

- Playback of a desired scene can be repeated five times.
- During lesson repeat, you can perform special playback such as still and frame advance (You cannot perform a reverse search).

1 Locate any desired scene to view repeatedly. Press the MEM/REP button of remote control unit at the starting point of the desired scene during playback. The "R" indicator will flash on and off. In the lesson repeat of a long scene, advance the scenes in the middle by forward search and resume PLAY mode again in time to locate the lesson repeat's ending point.

2 Press the MEM/REP button again at the desired ending point of the lesson repeat during playback. The "R" indicator will light up, and then the scene will be reverse searched to the starting point and the playback will be repeated five times. The display shows the remaining number of times for lesson repeat.

- The count of the remaining number of times during lesson repeat is judged by the number of times the scene end was reached in the Playback mode.
- You can reset the number of times the above operation is repeated (maximum of 5 times) by pressing the MEM/REP button.

Cancel

The lesson repeat is cancelled when the PLAY button is pressed during lesson repeat.

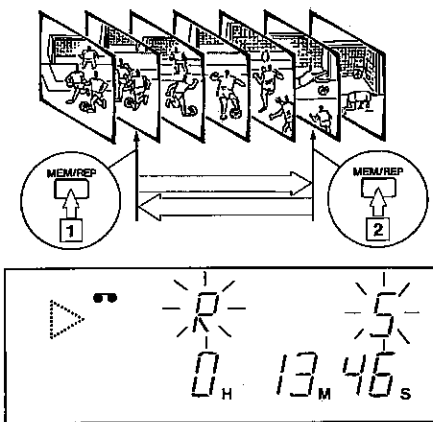
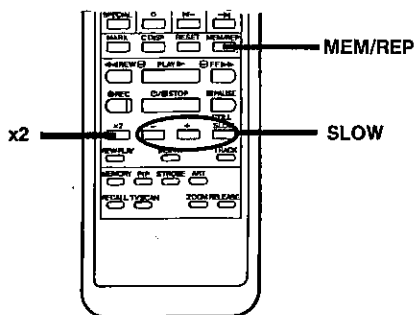

Notes:

- During the special playback (forward search, reverse search, still picture, frame advance and slow motion) the picture may contain some "noise" or vibration. But this is not a malfunction.
- If still picture playback is continued for about five minutes, the VCR will automatically change to normal playback in order to prevent the tape from damage.

TIMER RECORDING

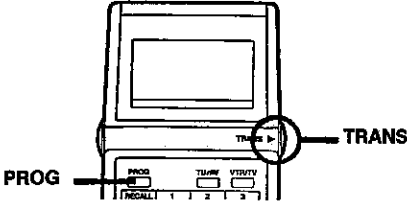

Example: Reserve channel 5 from 21:30 to 23:15 on December 24, 1988.

Insert a video cassette (with erasure-prevention tab).

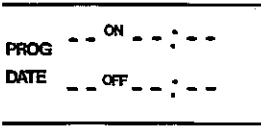

1

1 Press the PROG button.

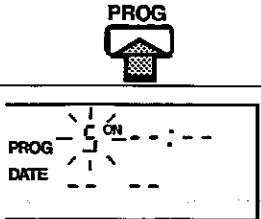

2

2 Set the CHANNEL with numeric button.
Example: channel 5



3 Set the DAY with numeric button.
Example: 24
Set the MONTH with numeric button.
Example: 12

Everyday recording

By making the day setting of step 3 equal to "0", the day and month display will become "0 0" to enable everyday recordings.

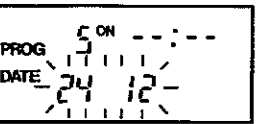

3

4 Set the ON-HOUR with numeric button.
Example: 21
Set the ON-MINUTE with numeric button.
Example: 30

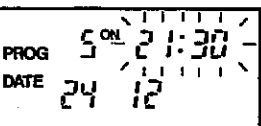

4

5 Set the OFF-HOUR with numeric button.
Example: 23
Set the OFF-MINUTE with numeric button.
Example: 15

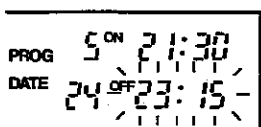

5

6 Press the TRANS button

Blinking of the remote function indicator () indicates that transmission is possible.

A maximum of 4 programmes can be memorized in the remote control unit. Hence transmission can be performed after 4 programmes have been set in steps 1 to 5. The procedure is to call out in sequence the program set with the PROG button and transmit them to the VCR by the TRANS button.

When program data is sent to the VCR, the VCR automatically assumes the timer standby mode and the Timer indicator () lights up.

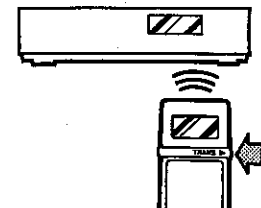

6

ERASURE OF REMOTE CONTROL UNIT PROGRAM DATA

Since only 4 programmes can be memorized in the remote control unit, if more than 4 programmes have been timer programmed, unnecessary programs must be cancelled and setting must be performed once again.

- 1 Press the PROG button to display on the remote control unit LCD panel the program data to be cancelled.
- 2 Press the → button.
- 3 Set the channel display to "0 0" with the numeric buttons.
- 4 Press the → button.

CONFIRMATION OF REMOTE CONTROL UNIT PROGRAM DATA

- 1 Each time the PROG button is pressed, program data memorized in the remote control unit is shown sequentially on the control unit LCD panel.
 - When the program memory of the remote control unit is available, if the PROG button is pressed, the initial program set mode (data input stand-by) is assumed.
 - To confirm day/month, press the → button twice during confirmation.
 - After all confirmations have been made, time display is assumed lastly.

REVISION OF REMOTE CONTROL UNIT PROGRAM DATA

- 1 Press the PROG button to display on the remote control unit LCD panel the program data to be revised.
- 2 Press the → (or ←) button until the number desired to be changed is blinking.
- 3 Press the numeric buttons and correct the number.
- 4 After revisions are completed, press the PROG button.

PROGRAM DATA TRANSMITTED TO VCR

The RECALL button is used to confirm, revise, or erase VCR data after it has been transmitted to the VCR from the remote control unit. The procedures are all the same as those after the PROG button is pressed.

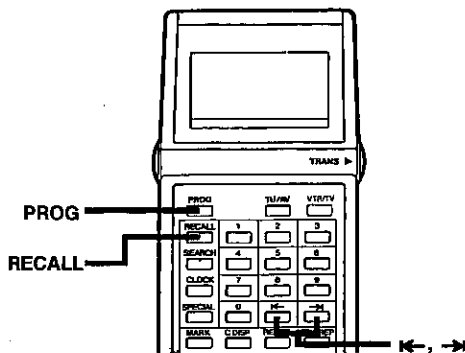

Notes:

- If an error occurs in the transmission of program data from the remote control unit, "ER (error)" is shown on the VCR display. In this case, set the infrared emitter component of the remote control unit properly in front of the VCR remote control detector and transmit once again.
- When the VCR's program memory is full, the VCR display reads as "FULL".
- If program setting is abandoned midway, the program is automatically cancelled.
- Year is not displayed in the program data of the remote control unit.

Remaining time display with timer notice

The total time of timer programming and the amount of time remaining on the loaded tape are shown automatically on the VCR digital display. After timer programming to the VCR side has been completed, the following data are displayed for about 5 seconds. The same data are displayed after program confirmation.

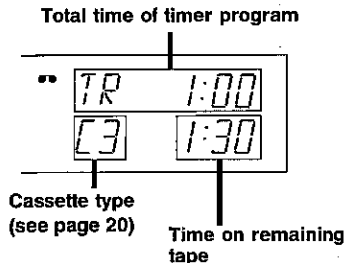

If the time on remaining tape is less than the total time of the timer program, the "TR" indicator blinks to warn that all the program cannot be recorded on the tape.

Note:

Everyday recording for one day is included in the total time of timer recording.

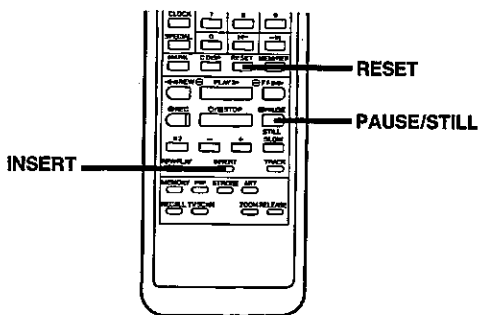

INSERT EDITING

Insert editing can only be used to revise the video signal track recorded on a tape. It cannot be used to revise the audio signal track (normal audio track).

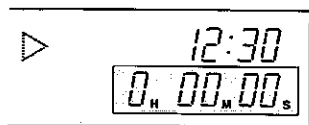
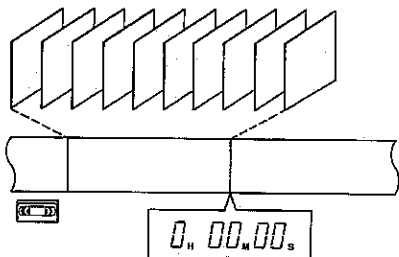

RESET



1

- 1 Press the counter RESET button to mark the ending point of insert.

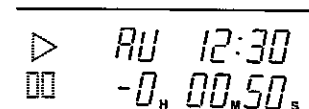

2

- 2 Search for the starting point of insert editing using the REW and PLAY button and so forth. Press the PAUSE/STILL button at the point to start insert.

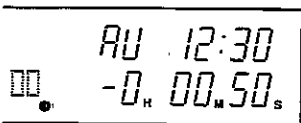

INSERT



3

- 3 Press the INSERT button, then the VCR will enter the insert stand by mode. Also the picture on the TV screen will change from a still picture of tape playback to the picture via AV input of TV program that you selected for insert recording.

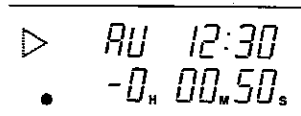

INSERT



4

- 4 Press the INSERT button again, then the VCR will begin insert.

- 5 The VCR will enter the STOP mode automatically at the ending point (counter 0H 00M 00s).

TAPE REMAINDER

This convenient function enables you to determine at a glance the duration of remaining tape.

TO CONFIRM DURING PLAYBACK, RECORDING, ETC,

- When the C DISP button is pressed once, the cassette type and duration of remaining tape are indicated by digital display.

Press the C DISP button after the tape has been running for about 10 to 20 seconds at standard tape speed (normal playback or recording). This time interval is essential for calculating the duration of remaining tape.

TO CONFIRM WHEN UNIT IS STOPPED

- Press the C DISP button once.

The VCR operates for several seconds to calculate the duration of remaining tape, and then indicates by digital display the cassette type and the remaining tape duration.

- Press the C DISP button once again to restore the original display.

IMPORTANT NOTICE

Automatic calculation and display of remaining tape duration can only be done with cassettes marked "○" as shown right. When using a different type of cassette, after the C DISP button has been depressed, input "CASSETTE NUMBER" with numeric buttons and press the \rightarrow button while the cassette type indicator ("C3") is flashing (about 5 seconds).

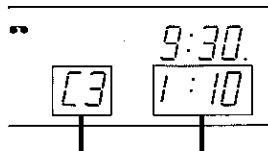
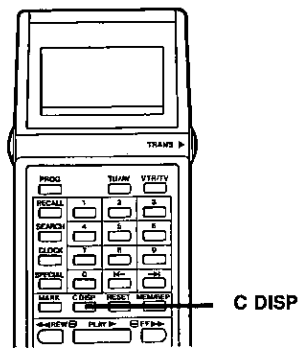

Cassette type indicator Remaining

Auto ID	Cassette	Cassette number	Cassette type display
○	E-30	30	03
○	E-60	60	C1
○	E-90	90	09
○	E-120	120	C2
○	E-150	150	15
○	E-180	180	C3
	E-195	195	19
	E-210	210	21
○	E-240	240	C4

INDEX SEARCH FUNCTION

This convenient function enables you to use the index signal recorded at the beginning of each programme to easily select the desired programme. Data is programmed at the LCD panel of the remote control unit and transmitted to the VCR.

RECORDING OF INDEX SIGNAL

- The index signal is recorded automatically at the beginning of each recording. While the index is being recorded, "Id" is shown on the VCR digital display.
- The MARK button can be used for manual index recording during record or playback.

INDEX SEARCH

This feature enables automatic search for and playback of a program whose INDEX number is known.

1 Press the SEARCH button once during STOP or PLAY mode.

2 Press the number using the numeric button to indicate how many programs before or after the present one you wish to watch.

Example: 15

- Any index number up to "99" can be designated.
- Press the ← button when revising.

3 When the desired programme is located after the present tape position, press the FF button.

When the desired programme is located before the present tape position, press the REW button.

4 Press the TRANS button.

FF or REW starts and when the designated index number is found, playback starts automatically.

To return the LCD panel to the initial display, press the SEARCH button twice.

- Index signal is not recorded after REC PAUSE.

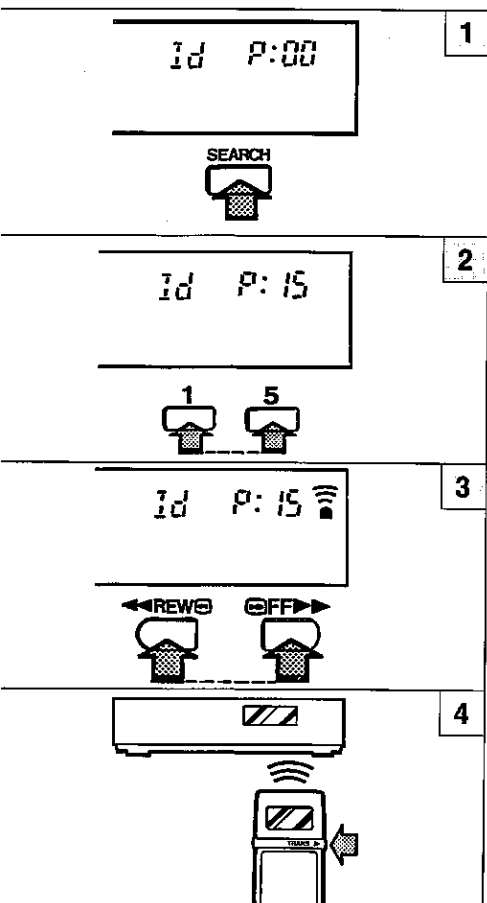
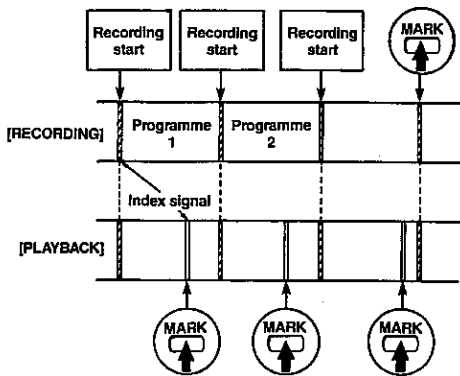
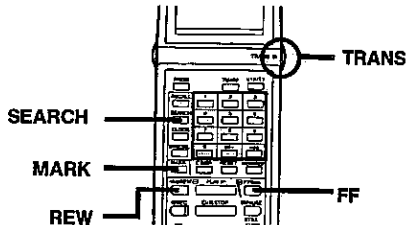

TO ERASE THE INDEX SIGNAL

Carry out the following procedures to erase a recorded index signal.

- 1 Playback the programme having the index signal you want to erase.
- 2 Press the SPECIAL button.
- 3 Input the special code "10" for index signal erasure with the numeric buttons. Press the ← button when revising.
- 4 Press the → button.
- 5 Press the TRANS button.
The VCR will start searching backwards toward the beginning of the programme and erase the index signal automatically.

To return the LCD panel to the initial display, press the SPECIAL button.

Note: Insert the index signal at least one minute apart from each other. If these signals are too close together, the unit will sometimes fail to operate normally during erase operation.

Notes:

- If you insert the index signal in the Playback mode, the audio will not be heard while the index signal is being recorded.
- In the playback mode, you cannot insert an index signal on a video cassette which does not have an erasure-prevention tab or non-recorded part of the tape.
- If you record or erase and index signal to or from a tape recorded using another VCR, the video programme at that point may be disturbed or it may be impossible to search it.

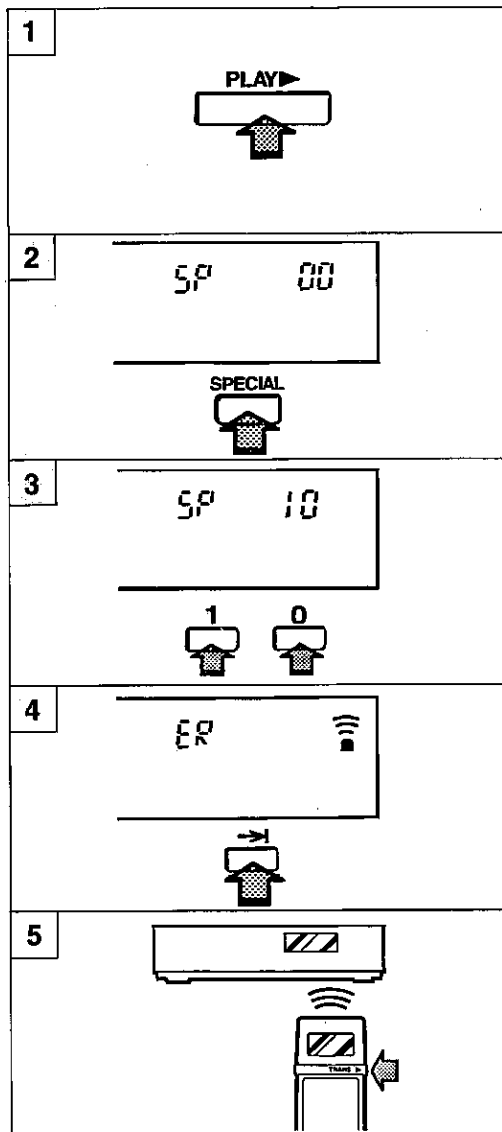
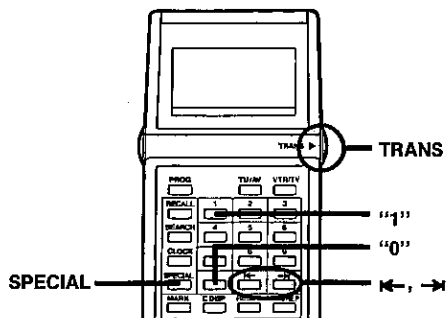

GO TO SEARCH FUNCTION

This feature enables forward and reverse search with reference to tape playing time.

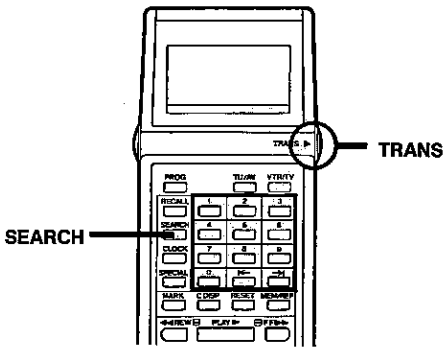

1 Press the SEARCH button **twice** during STOP or PLAY mode.

2 Input the time difference between the desired scene and present tape position, using the numeric buttons.

Example: 1 hour 20 minutes

Press the **←** button when revising.

3 When the desired programme is located after the present tape position, press the FF button. When the desired programme is located before the present tape position, press the REW button.

4 Press the TRANS button.

Tape will advance at fast speed to the desired scene and then starts playback.

Note: The error between the designated time and the counter reading is about ± 30 seconds.

To return the LCD panel to the initial display, press the SEARCH button.

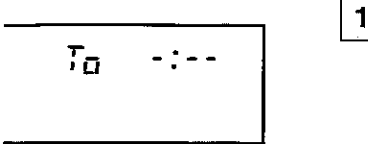

SEARCH

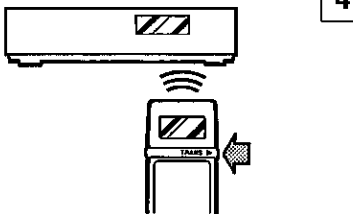
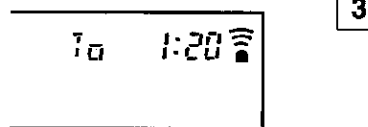
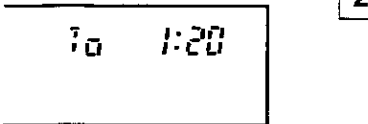

SPECIAL CODE FUNCTION

For your convenience, this VCR has various special functions using SPECIAL CODE. The special functions can be implemented by input of the SPECIAL CODE in step 2.

- 1 Press the SPECIAL button
- 2 Input 2-digit SPECIAL CODE with numeric buttons.
Example: "01" (DIMMER)
 Press the ← button when revising.
- 3 Press the → button.
- 4 Press the TRANS button.

"00" — **GO TO REC BEGIN:** To prepare for the next recording on a tape, the beginning of a non-recorded area is searched for automatically.

- 1 Insert cassette tape and transmit SPECIAL CODE "00".

"01" — **DIMMER:** Changes digital display brightness.

- 1 With power on, transmit CODE "01".
- 2 To restore original brightness, transmit "01" once again.

"10" — **INDEX ERASE:** Erases the index signal. (See page 22)

"90" — **AUTO DEMONSTRATION:** Demonstrate various digital functions automatically.

- 1 With power on, transmit CODE "90".
- "91"** — **ENDLESS PLAY:** Plays back tape repeatedly from beginning to end (from tape start to "0H 00M 00s" in case of counter memory).

- 1 Insert cassette tape, and transmit SPECIAL CODE "91"
- Playback starts once the tape has been rewound to the beginning.

"92" — **ENDLESS RECORD:** Records tape repeatedly from beginning to end.

- 1 Insert cassette tape, and transmit SPECIAL CODE "92".
- Recording starts once the tape has been rewound to the beginning.

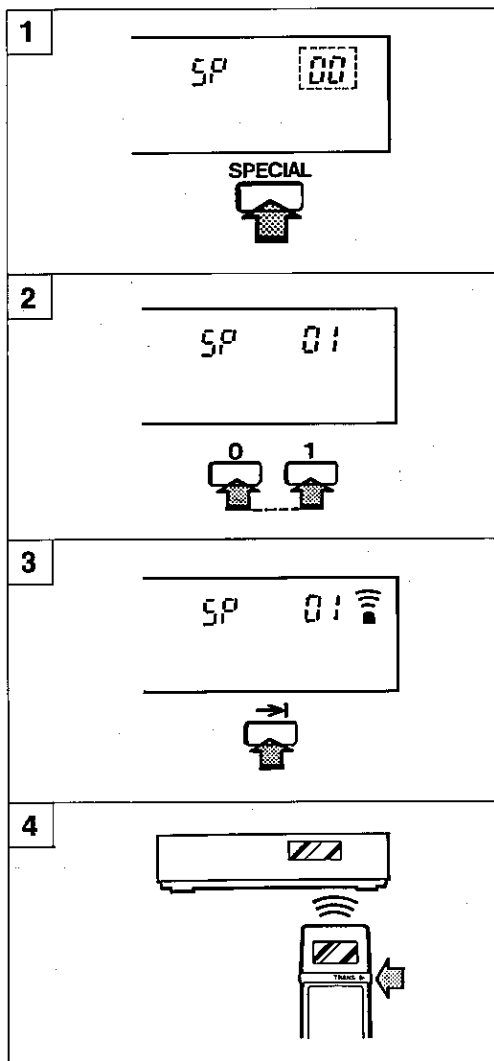
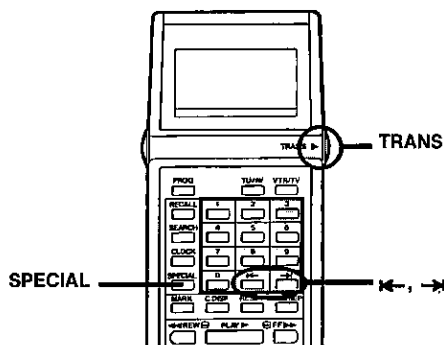

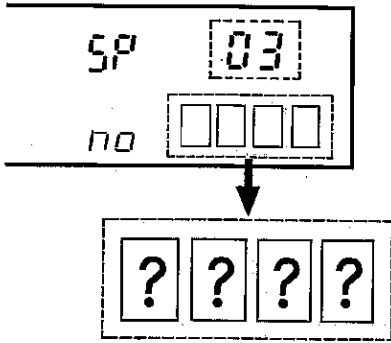

SECRET NUMBER

“03” — PLAY KEY LOCK: Prevents all operation from the VCR so that children cannot playback any pre-recorded tape.

- 1 With the power on, after SPECIAL CODE “03” has been input, enter a four-digit secret number (Example: “1 2 3 4”) with the numeric buttons and transmit it. When the PLAY KEY LOCK is engaged, the “j” indicator is shown on the display. If the PLAY button is pressed while the PLAY KEY LOCK is engaged, the playback indicator “▷” blinks to notify of PLAY KEY LOCK status.

- 2 To cancel the lock function, transmit the same secret number (Example: “1 2 3 4”) once again.

“04” — CHANNEL LOCK: Locks certain channel positions so that children cannot watch programmes for adults (up to 3 positions). Select the channel position to be concealed, then perform the following operations.

- 1 Select the channel position number of the CHANNEL to be locked.

- 2 After SPECIAL CODE “04” has been input, input a four-digit secret number (Example: “5 6 7 8”) with the numeric buttons and transmit it.

When the CHANNEL LOCK is engaged, the “j” indicator is shown on the display.

When a channel position number with CHANNEL LOCK ENGAGED has been selected, a screen image does not appear, but the channel position number blinks to notify CHANNEL LOCK status.

The same procedure can be repeated to engage the CHANNEL LOCK in 3 positions.

- 3 To cancel the lock function, transmit the same secret number (Example: “5 6 7 8”) once again.

Note: When cancelling PLAY KEY LOCK or CHANNEL LOCK, if the secret numbers do not match, “Error” is displayed.

If you forget the secret number entered and cannot cancel it, clear with the ALL CLEAR button. When the ALL CLEAR button is pressed, the preset clock and timer programme data are all cleared.

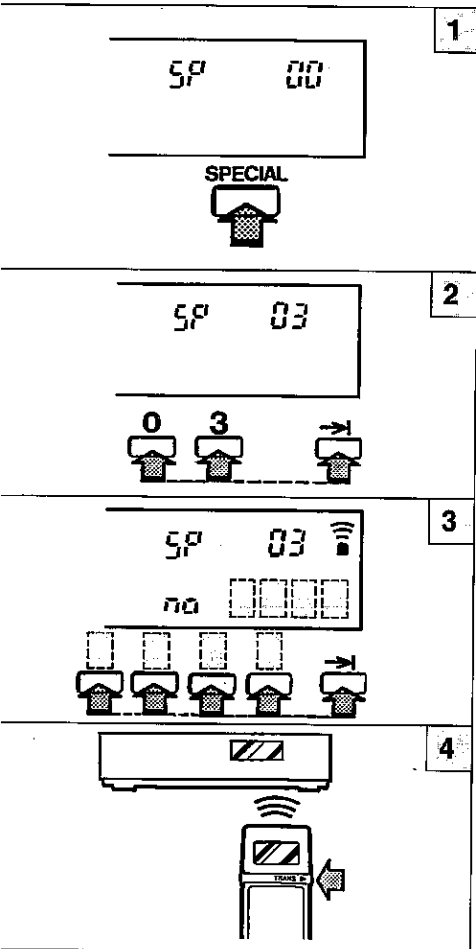

DIGITAL EFFECTS

Use the digital functions provided with this unit to enjoy various kinds of digital play. Perform operations mainly using the remote control unit.

MEMORY STILL

- You can freeze an on-air TV picture or playback picture while listening to the audio.
- By pressing the MEMORY button during a picture replay, the picture will freeze. However, the tape will continue run. If you wish to watch a still picture with the tape stationary, press the PAUSE/STILL button.

1 Watch the TV picture or playback picture.

2 Press the MEMORY button.
Cancel
Press the MEMORY button or the RELEASE button.

3 Press the RECALL button, the picture will change from MEMORY STILL to the present moving picture.

MEMORY RECALL

You can recall the picture afterwards once you memorized before.

4 Press the RECALL button, the frozen picture which was memorized in step 1 will appear again.
Cancel
Press the RELEASE button.

Notes:

- When using this unit for profit or public viewing in a coffee shop, hotel, or the like, if you display two or more screens or add special video effects using the 9-screen or 2-screen function of the unit, you run the risk of infringing upon the rights of the author, which are protected by the Copyright Act.
- The digital functions do not operate during video recording.
- The picture may sometimes be disturbed when you switch over between a normal picture and a digital picture.
- The picture may sometimes be disturbed in the horizontal direction near the centre of the screen when zooming the centre of the picture.
- The digital scan picture may be cut off at the top and bottom or the size in the left-right direction may change.

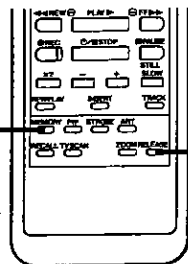

MEMORY

RELEASE

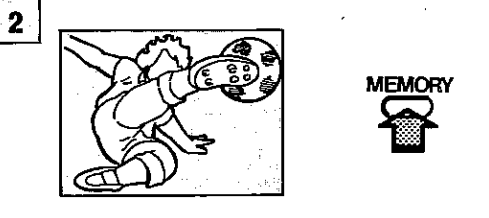
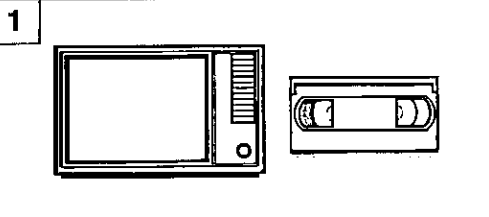

MEMORY INSERT

You can record a recalled picture by inserting into any pre-recorded position of the tape.

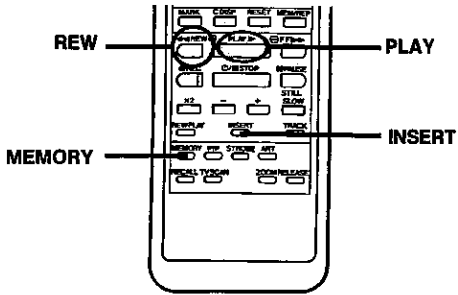

1 Press the MEMORY button, the memory still picture will appear.

2 Press the INSERT button, the VCR will go to memory insert stand by mode.

3 Search the starting point of memory insert using the REW and the PLAY etc. buttons. Turn back to PLAY mode pressing the PLAY button.

Note: At this time, you can not operate the still, slow motion or digital effects which are being used in the digital memory.

4 Press the INSERT button again, the VCR will start the memory insert. The VCR will turn to stop mode automatically after 30 seconds or it will turn to stop mode automatically at the point, counter 0h 00m 00s.

And also it will turn to stop mode if you press the STOP button.

1

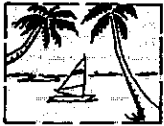

2

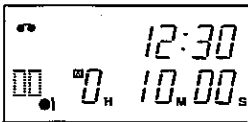

3

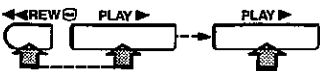

4

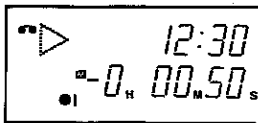

MONO STROBE

You can stop the motion of the picture in fine steps, just as if you are looking at strobe photographs.

1 Watch the TV picture or playback picture.

2 Press the STROBE button twice.

Changing the strobe speed

You can change the strobe speed by pressing the - or + button. (-: Speed decreases, +: Speed increases)

3 Cancel

Press the RELEASE button.

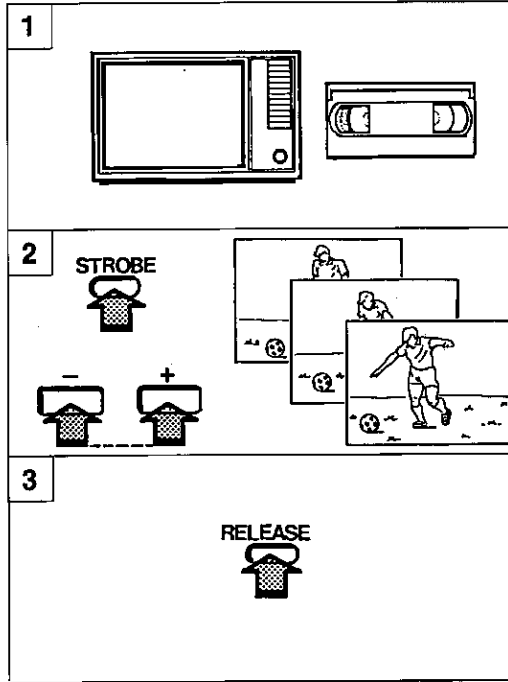
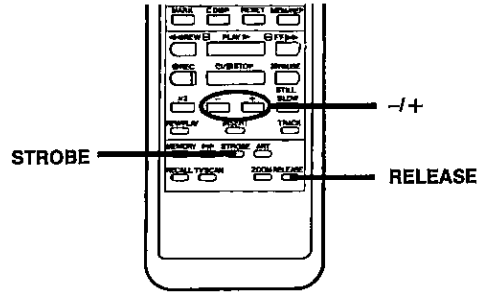

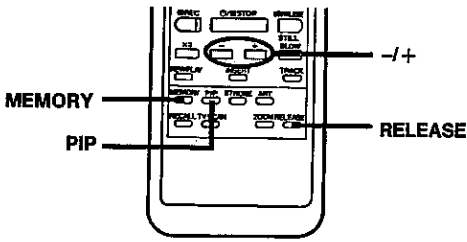

PIP (Picture In Picture)

- You can watch two pictures simultaneously on the same screen. For example, you can watch a playback picture on a TV screen while watching a TV picture on a sub screen within the TV screen or vice versa.
- You can only hear the sound accompanying the picture of the main screen.

1 Watch the playback picture or TV picture.

2 Press the PIP button.

3 Select the programme that you wish to watch on the sub screen. You can switch the input source to obtain various combinations.

The following input source combinations are possible:

Playback picture and TV picture
 Playback picture and External picture
 TV picture and External picture

Screen switch-over

Each time you press the PIP button, the main screen and sub screen will be interchanged.

Moving the sub screen

You can change the position of the sub screen by pressing the - or + button. (-: Sub screen moves counterclockwise, +: Sub screen moves clockwise)

Sub screen Memory Still

When the MEMORY button is pressed, the picture on the sub screen will freeze.

When the MEMORY button is pressed once again, the picture on the sub screen will revert to the original moving picture.

4 Cancel
 Press the RELEASE button.

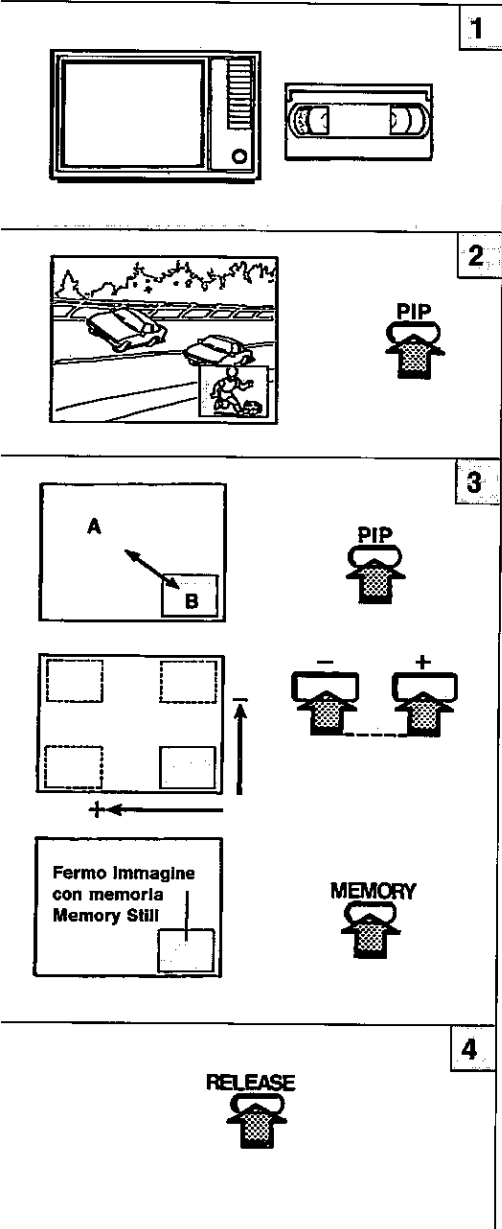

MOSAIC/PAINT PICTURE

- You can create a mosaic-like picture.
- You can enjoy video oil painting-like video effects.

1 Watch the TV picture or playback picture.

2 Press the ART button. Subsequently, each time you press the ART button, the picture will change in the sequence.

Paint Picture → Mosaic Picture → Paint Picture

Variable

You can vary the size of the mosaic elements using the - or + button. (-: Decreases, +: Increases)

You can augment or reduce the paint effect using the - or + button (-: Reduce, +: Augment)

Still picture mosaic

When the ART button is pressed while the system is in the Still status, a still mosaic will appear on the screen.

Still picture paint

When the ART button is pressed twice while the system is in the Still status, a still painted picture will appear on the screen.

3 **Cancel**
Press the RELEASE button.

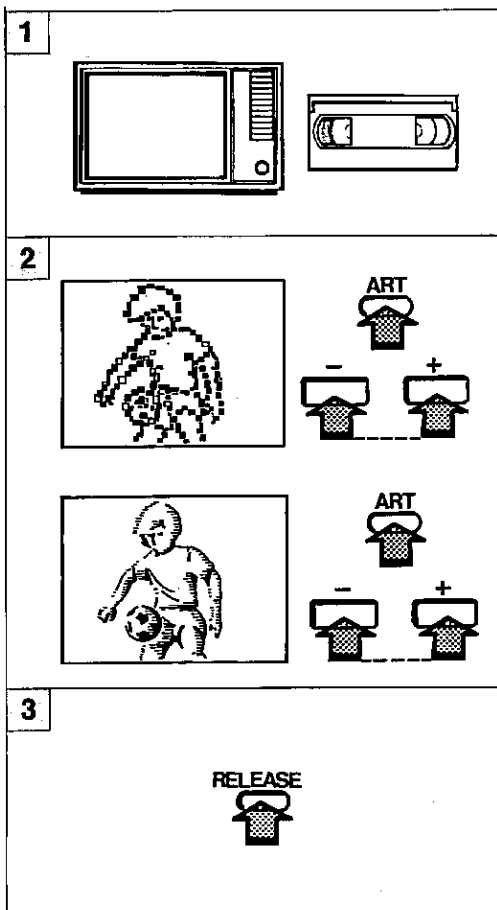
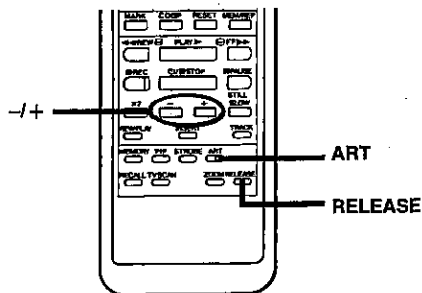

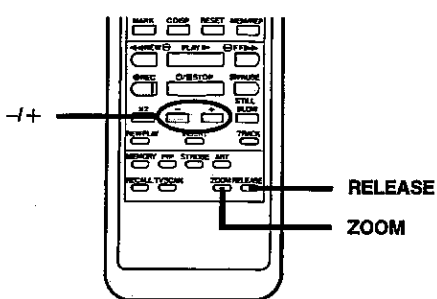

ZOOM PICTURE

- You can divide the TV screen into five parts, and enlarge the picture in one part so that it fills the entire screen.

1 Watch the TV picture or playback picture.

2 Press the ZOOM button. Zoom the picture in the centre portion of the screen.

Variable magnification (centre picture only)

Each time you press the ZOOM button, the magnification will change in the sequence x4 → x9 → x16 → Normal.

Selecting zooming point (corner picture only)

You can select the corner picture zooming point by pressing the - or + button while zooming the centre picture. (The zoom ratio for the corner picture is x 4 only.)

If you press the ZOOM button while zooming a corner picture, the picture on the screen will revert to the normal picture.

Still picture zoom

If you press the zoom button when a still picture is displayed, the still picture will be zoomed.

Note: An enlarged picture will appear like a mosaic.

3 Cancel

Press the RELEASE button.

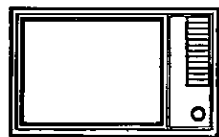

1

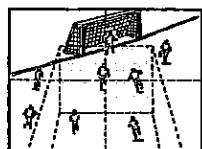

2

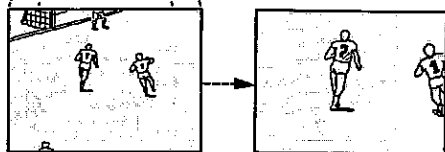

(x4) → (x9) → (x16)

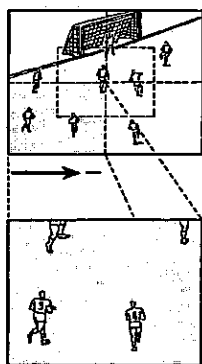

(x4)



3



CYCLE STROBE

- The picture in the centre screen will continue to move, while still pictures in the digital memory will appear successively in clockwise rotation on the eight screens surrounding the centre screen.

1 Watch the playback picture or TV picture.

2 Press the STROBE button.
Changing the strobe speed
 You can change the strobe speed by pressing the - or + button. (-: Speed decreases, +: Speed increases)

3 **Cycle Memory Still**
 When the MEMORY button is pressed while the system is in the Cycle Strobe status, the picture on the centre screen will continue to move, and the pictures in all of the strobe screens surrounding it will become still pictures.
 When the MEMORY button is pressed once again, the system will return to the Cycle Strobe status.

4 **Manual Cycle Strobe**
 While the system is in the Cycle Strobe status, press the MEMORY button, then while watching the moving picture press the - or + button when the desired scene appears. The picture which was displayed on the centre screen will become a still picture each time the - or + button is pressed. (-: Indicates counterclockwise direction, +: Indicates clockwise direction)
 When the MEMORY button is pressed once again, the system will return to the Cycle Strobe status.

5 **Cancel**
 Press the RELEASE button.

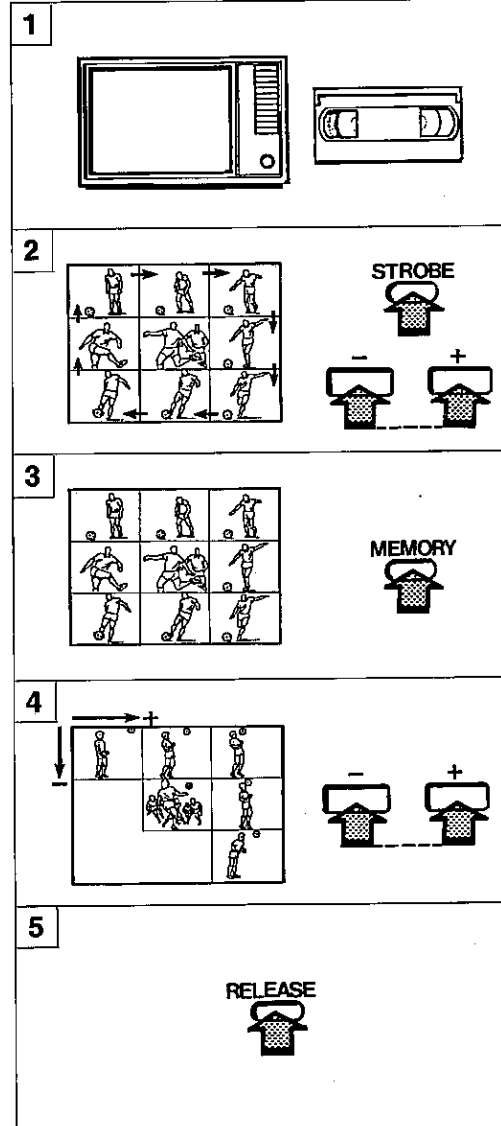
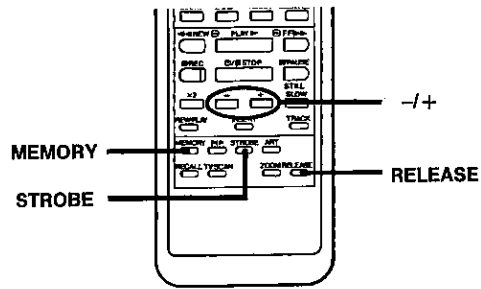

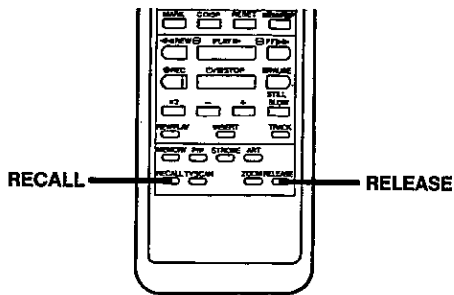

PRE-CYCLE MEMORY

- You can see 8 still pictures circulating on the divided screen that have been previously memorized.

- 1** Watch the TV picture or playback picture.
- 2** Press the RECALL button.
The PRE-CYCLE MEMORY pictures will appear.

Important notice:

- If the MEMORY STILL picture is memorized in the system, the MEMORY STILL picture will appear on the screen. In this case, cancel the MEMORY STILL picture by pressing the RELEASE button first.

- 3** **Cancel**
Press the RELEASE button.

Note: The position of the divided screen that has been previously memorized.

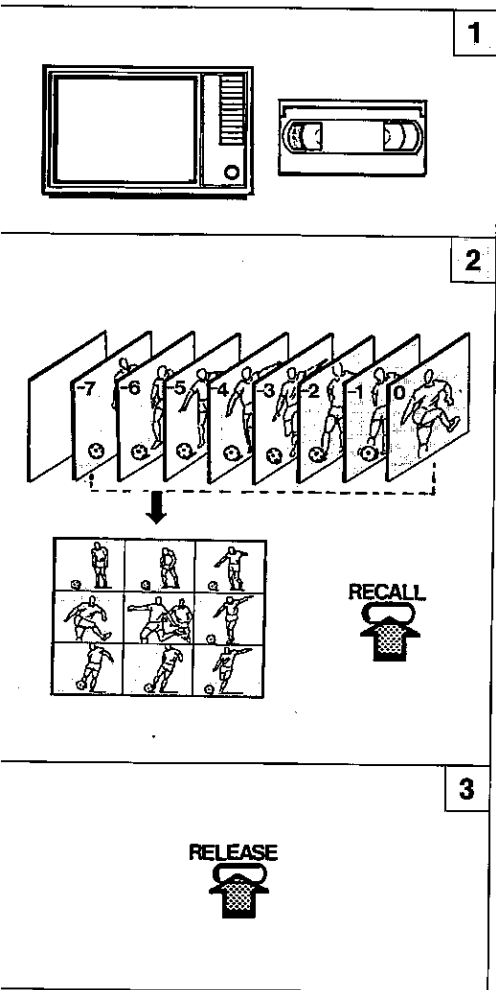

MULTI TV PROGRAMME SCAN

- You can simultaneously display four or nine broadcast programmes at a time on a single screen, enabling you to see the contents of the TV broadcasts at a glance.
- The portions of the screen corresponding to non-preset channel position numbers will remain blank. SKIP mode positions will not appear on the screen.
- You cannot hear the audio of the displayed programmes.

1 Press the TV SCAN button. Nine channels at a time will be displayed successively as still pictures from low channel numbers. When the TV SCAN button is pressed again, the next nine programmes will be displayed.

9-screen/4-screen selection

By pressing the - button on the remote control during the 9-screen display, the 4-screen display scan will appear. By pressing the + button, the 9-screen display scan will appear once again.

2 Programme selection

By designating the position corresponding to the programme that you wish to see using one of keys 1 to 9, the selected programme will appear over the entire screen.

In the case of the 4-screen display, select the desired program by using numeric buttons 1, 3, 7, and 9.

TV SCAN

-/+

1

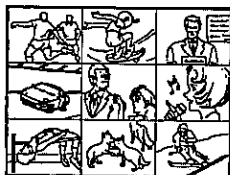

TVSCAN



2

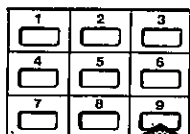
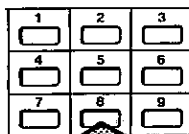
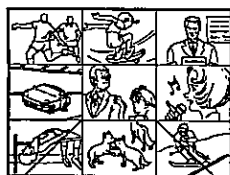

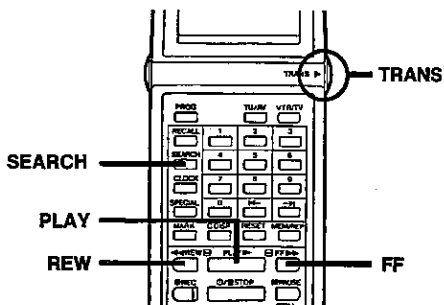

MULTI INDEX SCAN

- By detecting the index signals recorded on a video tape, you can successively display nine pictures from the tape and hold them in the form of a multiple display, enabling you to see the recorded contents of the tape at a glance.

1 Press the SEARCH button during the STOP or PLAY mode.

2 Press the FF or REW button according to the desired search direction then press the TRANS button.

3 Each time an index signal is detected, the corresponding picture will be played back for 5 seconds, then will remain on the screen as a still picture. In this way, still pictures will be successively displayed on the screen.

4 Programme selection
If you press the PLAY button during the 5-second playback period of a programme that you wish to see, the system will go into the normal PLAY mode.

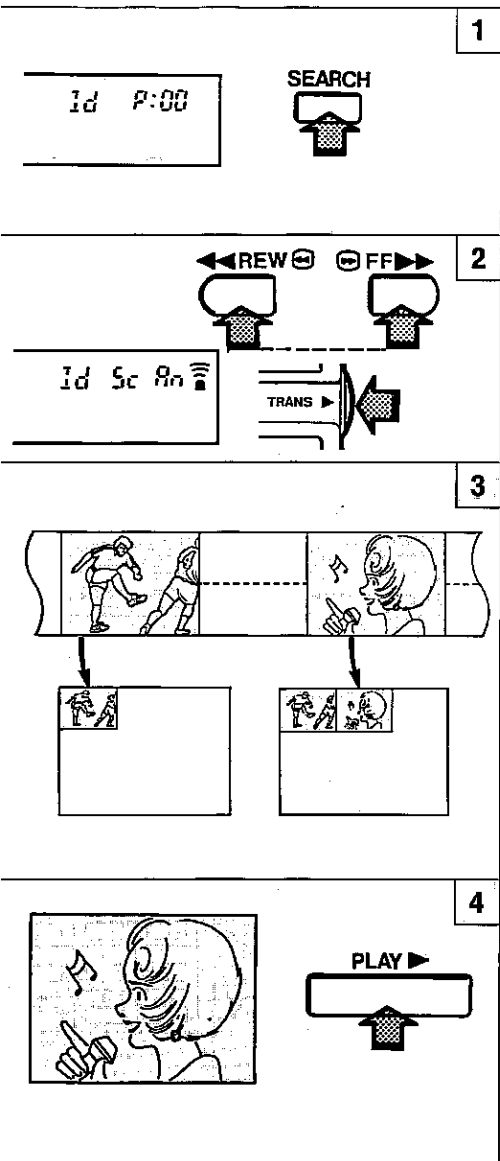

MULTI MEMORY INSERT

You can record a recalled picture by inserting into any pre-recorded position of the tape.

- 1 Create the multi index picture, using the multi index scan function. (See page 35)
- 2 Press the INSERT button, and the VCR will enter the memory insert stand by mode.
- 3 Search for the starting point of memory insert using the REW and PLAY buttons and so forth. Return to PLAY mode by pressing the PLAY button.
- 4 Press the INSERT button again, and the VCR will start memory insert. The VCR will enter the stop mode automatically after 30 seconds or it will enter the stop mode automatically at the ending point, (counter 0h 00m 00s), it will also enter the stop mode if you press the STOP button.

Note: At this time, you cannot operate still, slow motion or digital effects which are being used in the digital memory.

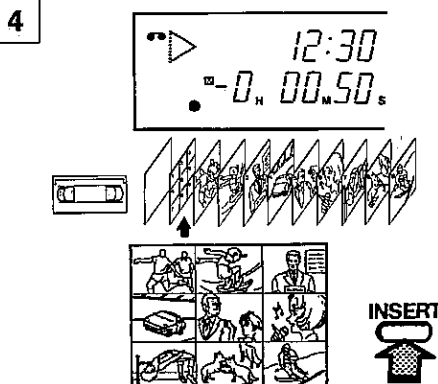
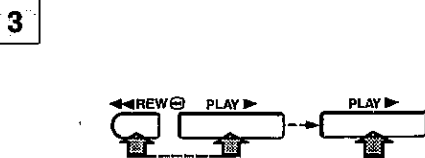
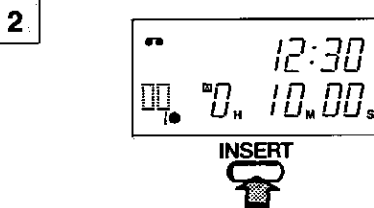
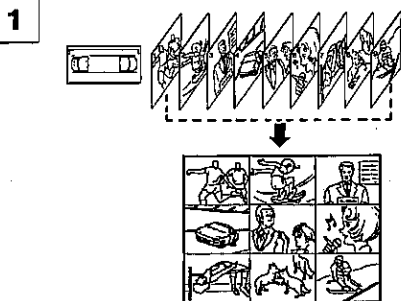
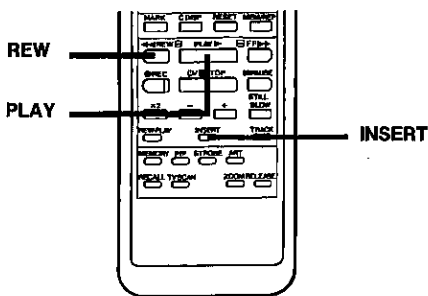

REPAIRS

This VCR is a precision instrument and treated with care, will provide years of satisfactory performance. However, in the event of difficulty, the owner is advised not to attempt to make repairs or open the cabinet. Servicing should always be referred to your servicing dealer or SANYO Authorized Warranty Station.

TROUBLESHOOTING

This VCR is highly sophisticated. It is shipped from the factory after having been checked and adjusted under the most rigid quality control and inspection system. Should problems occur, check the following points.

Symptom	Check points
No power	<ul style="list-style-type: none">• The power cord is disconnected.
No off the air programmes	<ul style="list-style-type: none">• Are the connections between your VCR and TV correct.• Off the air reception on the VCR is poor.• The TV channel selector has not been set to VCR operating channel (channel 0 or 1 for AUSTRALIA, channel 2 or 3 for NEW ZEALAND).
No recording	<ul style="list-style-type: none">• The erasure-prevention tab on the cassette has been removed.
Timer recording is not possible	<ul style="list-style-type: none">• The starting day and time have not been set correctly.• The clock time is not set correctly.• There has been a power interruption.
Playback picture does not appear	<ul style="list-style-type: none">• The TV channel selector has not been set to VCR operating channel (channel 0 or 1 for AUSTRALIA, channel 2 or 3 for NEW ZEALAND).
Interference on playback picture	<ul style="list-style-type: none">• Adjust the TRACKING control.• Dust and dirt on video heads.• Take the VCR to an Authorized Service Station or dealer.

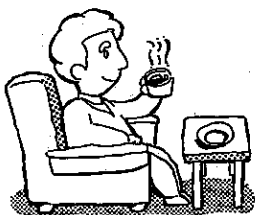

SPECIFICATIONS

General

Video format: VHS PAL
Television system: CCIR: 625 lines, PAL colour signals
Recording system: Rotary two heads helical-scan system
Tape speed: 23.39 mm/sec
Recording/Playback time: 240 minutes with E-240
Tuner input:

For AUSTRALIA	For NEW ZEALAND
VL: 0 — 5	VL: 1 — 3
VH: 5A — 11	VH: 4 — 11
U: 21 — 65	U: 21 — 65

RF converter: Built-in VHF converter
Converter output: On channel 0 or 1.... AUSTRALIA
On channel 2 or 3.... NEW ZEALAND
Timer indication: 24 hour indication
Power failure backup: Approx. one hour
Timer recording: 1 year 8 programmes with every day function
Power requirement: AC 220 — 240V $\pm 10\%$, 50 Hz
Dimensions (W x H x D): 420 x 79 x 317 mm
Weight: 5.9 kg
Power consumption: 35 W

Electronic characteristics

Video input level: 0.5 — 2.0 Vp-p
Video input impedance: 75 ± 5 ohms
Video output level: 1.0 ± 0.2 Vp-p
Video output impedance: 75 ± 5 ohms
Video S/N: Luminance: more than 43 dB
Resolution: Colour: more than 240 lines
Audio input level: -20 dBs
Audio input impedance: More than 50 kohms
Audio output level: -8 dBs
Audio output impedance: Less than 10 kohms

Remote control unit

Power requirements: 3 V (two "AA" size, 1.5-volt batteries)

Accessories

Instruction manual 1
Antenna output cable 1
Remote control unit 1
"AA" size, 1.5 volt batteries 2

Appearance and specifications are subject to change without notice.

1AC6P10A09900
DP2F/A,NZ (0936SY01)

SANYO

SANYO Electric Co., Ltd.
Printed in Japan