

INSTRUCTION MANUAL
PETUNJUK PEMAKAIAN
使用説明書
사용설명서

ABC-VW24

AIR PURIFIER
PENYARING UDARA
空氣淨化機
공기 정화기

	Page
English	E-1 – E-14
Indonesia	I-1 – I-14
中文	C-1 – C-14
한국어	K-1 – K-14

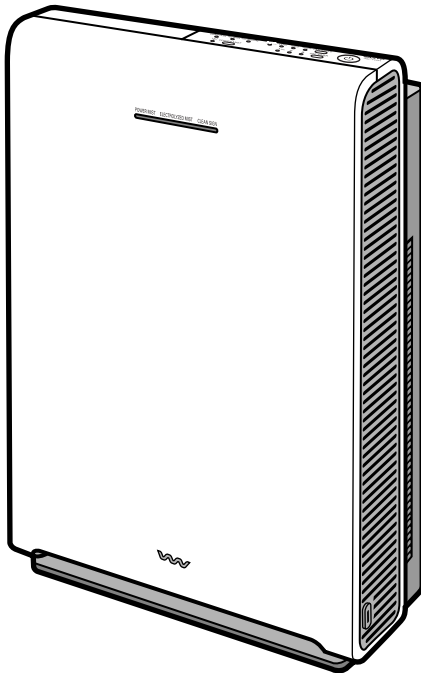

English

Indonesia

中文

한국어

Precautions

- Read the “Precautions” carefully before using this device to ensure proper operation.
- Follow these precautions to ensure the safe and proper operation of this device and to prevent injury or damage to you or any others. In addition, the presumed results of mishandling this device are divided into “Warning” and “Caution” to specify the extent of injury or damage that can be expected and degree of urgency. Always ensure that these instructions are followed as they are related to important safety issues.

Warning

Do not modify this device. Any disassembly or repair should be conducted by qualified technicians.

This may cause a fire, electrical shock, or injury. Consult with the place of purchase regarding any repairs.

Remove the power plug from the wall outlet before cleaning. In addition, do not insert or pull out the power plug with wet hands.

This may cause an electrical shock or injury.

Do not use this device if the cord or power plug is damaged or if the wall outlet is loose.

This may cause an electrical shock, short circuit, or fire.

Do not scratch, damage, modify, forcefully bend, pull, twist, or bundle the power cord. In addition, do not place heavy objects on or clamp the cord.

This will damage the cord and may cause a fire or electrical shock.

Use only the specified voltage as the power source.

This may cause a fire or electrical shock.

Caution

Do not hold the cord when unplugging from the wall outlet. Always hold the end of the power plug when unplugging the cord.

In addition, periodically wipe away any dust on the power plug.

This may cause a fire from an electrical shock or short circuit.

Do not wipe with kerosene or paint thinner and do not spray with insecticides.

This may cause the cord to crack, an electrical shock, or fire.

Caution

Ensure there is adequate ventilation when using this device with combustible appliances.

This may cause carbon monoxide poisoning.

- This device does not eliminate carbon monoxide.
-

Ensure that combustible material or cigarette or incense particles still on fire are not drawn into this device.

This may cause a fire.

Do not use in places with oil particles, i.e. from machinery, suspended in the air.

This may cause cracks or the falling of this device may cause injury.

Ensure that the power plug is removed from the wall outlet when this device is not in use for long periods of time. Dispose of the water in the electrolyzed water unit and tank.

This may cause an electrical shock or fire.

Without electricity, the effect of the electrolyzed water is reduced and mold and bacteria may develop.

Do not place fingers or foreign objects in the air intake or vent.

This may cause an electrical shock or malfunctions.

Do not use this device in extremely humid environments, i.e. bathrooms.

This may cause an electrical shock or malfunctions.

- Store this manual in an accessible location after reading.

Part Names and Functions

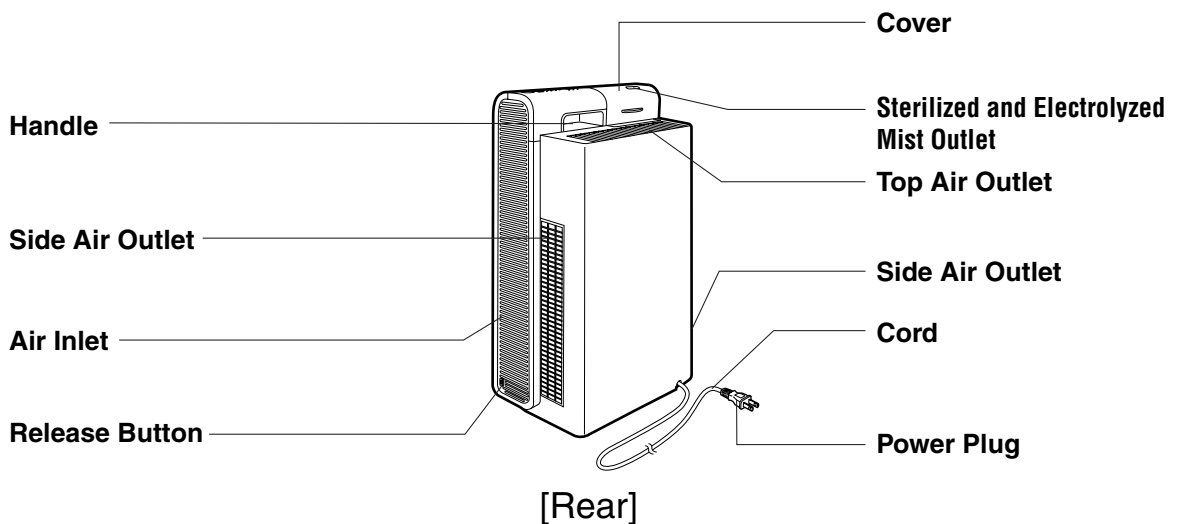
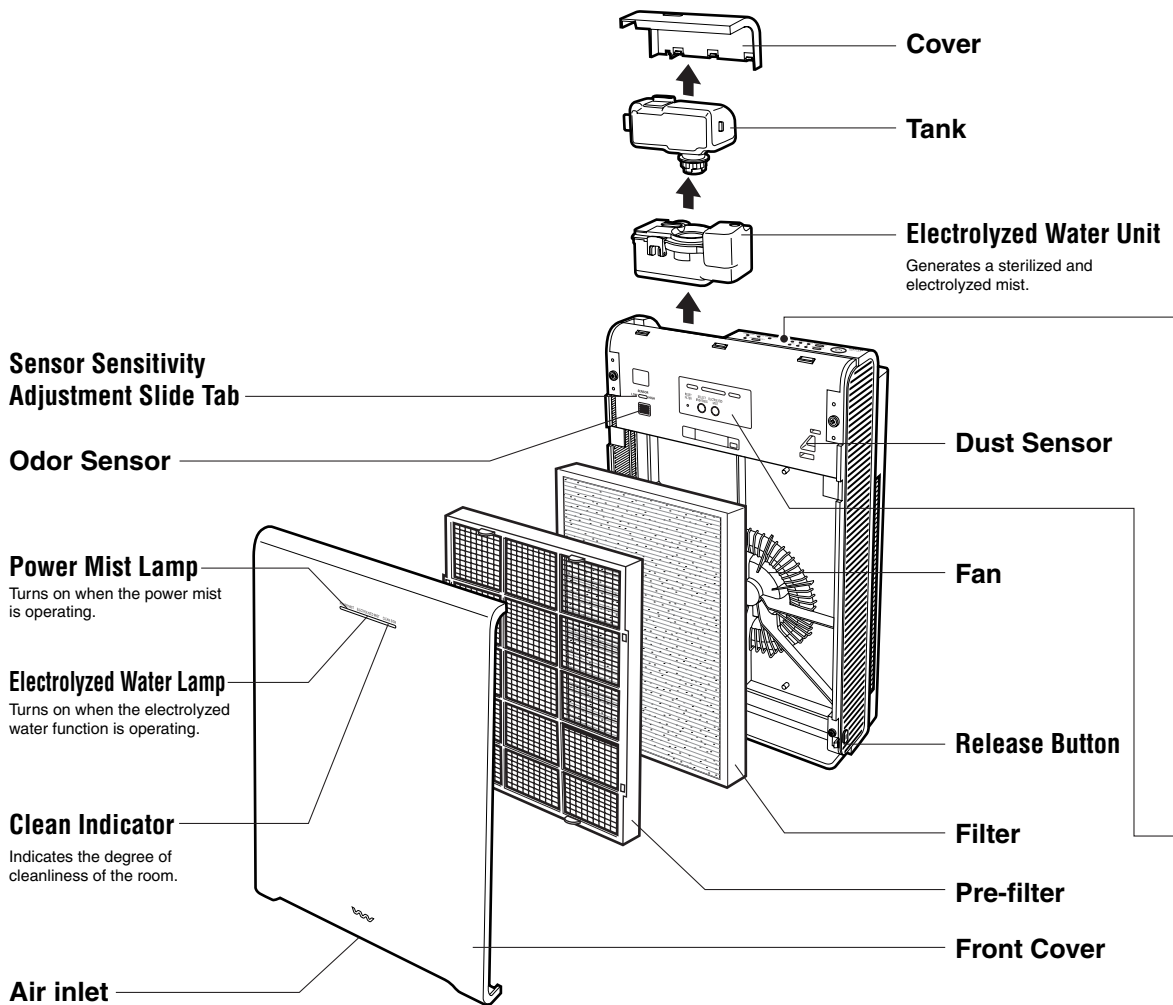

Operating Unit

Filter Replacement Lamp (Red)

Turns on when the filter needs to be replaced.

Add Water Lamp (Red)

Turns on when the water needs to be replenished.
Turns on when the device needs to be cleaned.

Air Flow Indicator (Green)

Power On/Off Button

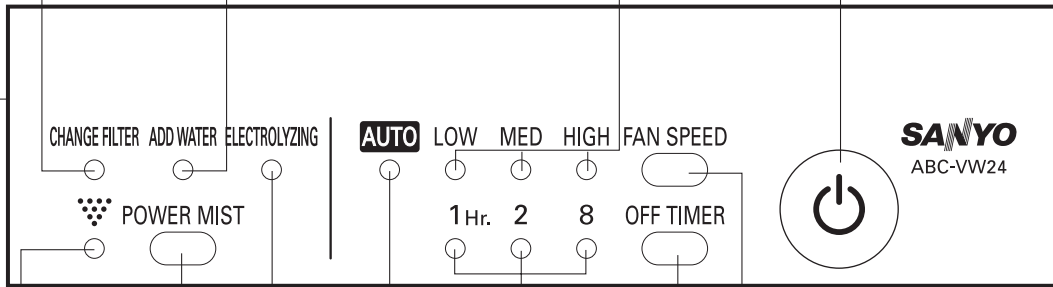

Power Mist Button

Timer Indicator (Green)

Fan Speed Button

Off Timer Button

Power Mist Lamp (Green)

Turns on when the power mist is operating.

Electrolyzed Water Lamp (Green)

Turns on when the electrolyzed water function is operating.

Automatic Operation Lamp (Green)

Remove the front cover before operating.

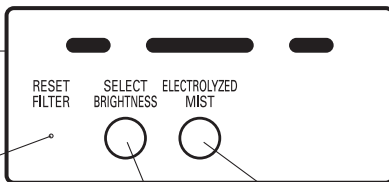

Filter Reset Button

Press this button after replacing the filter.

Electrolyzed Water Button

Select Brightness Button

Safety Mechanism

■When this unit tips over, the device is automatically stopped.

- Stand the device correctly and press the Power On/Off button to restart.
- If water spills from the electrolyzed water unit and tank, ensure that the spill is cleaned and dry completely before operating the unit.
- The unit cannot be operated while tilted.
- The memory is cleared.

<Removing the Front Cover>

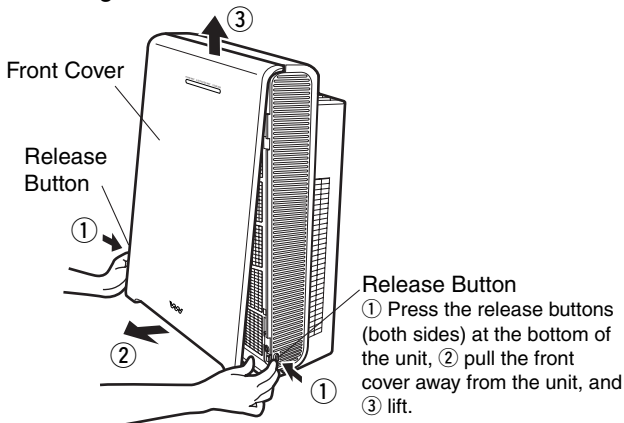

Confirm the accessories.

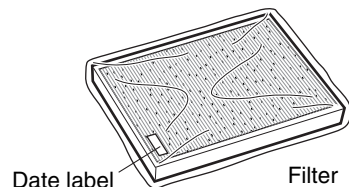

(The filter has been placed within the device during shipping. Remove the plastic protector and replace the filter into the unit. Refer to page E-5)

Preparations Before Use

Installing the Filter

1 Remove the front cover

- ① Press the Release buttons (both sides) at the bottom of the unit, ② pull the front cover away from the unit, and ③ lift.

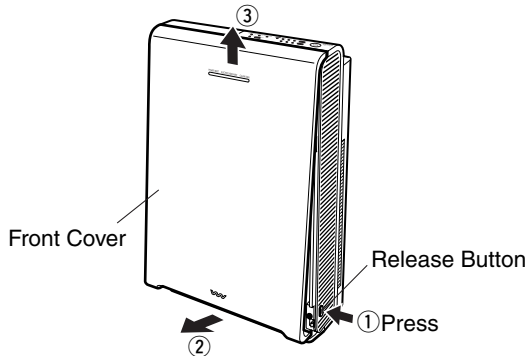

2 Remove the pre-filter (filter).

- Hold the tabs of the pre-filter and pull to remove.

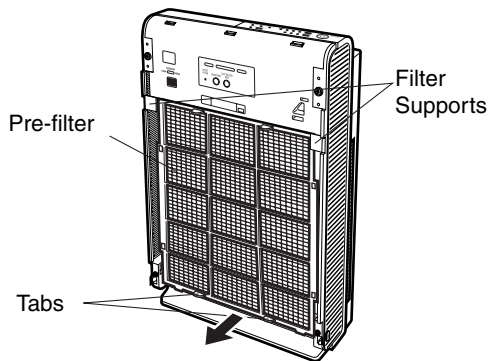

3 Remove the pre-filter from the filter and remove from the plastic protector.

- Widen the frame of the pre-filter and remove the filter.

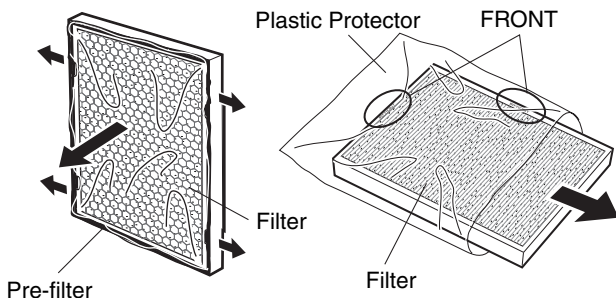

4 Attach the filter to the pre-filter.

- Insert the side printed with the word "FRONT" into the side of the net.
- Widen the frame of the pre-filter and insert the filter with the tabs to the bottom.

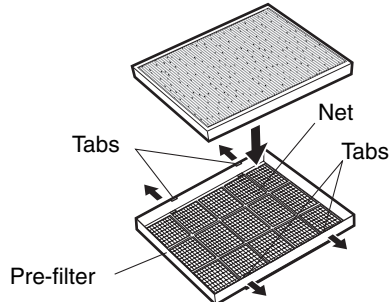

5 Attach the pre-filter.

- Ensure that the tabs of the pre-filter are to the front. ① Insert the filter under the filter supports at the top and then ② push the filter in at the bottom.

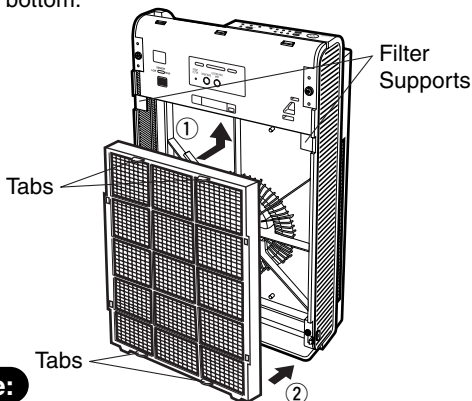

6 Attach the front cover.

- ① Place the tabs (3) at the top of the front cover into the attachment slots.
- ② Press the bottom until the cover clicks.

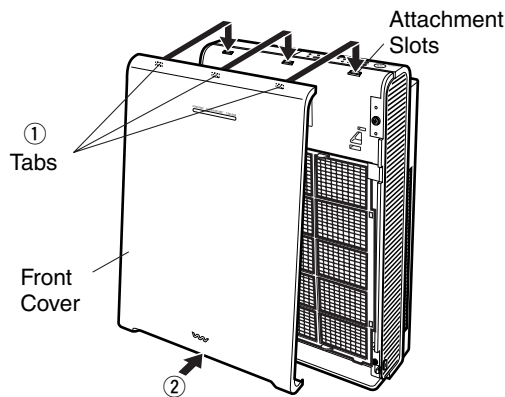

Note:

- If the plastic protector is not removed from the filter, the device will not clean the air. In addition, this may cause a malfunction.
- Write the date of the filter installation on the date label as a guide for the filter replacement and attach the label to the unit.

Warning

Do not place flammable material in the tank. This may cause a fire.

Replenishing the Water

- 1** Lift the tab on the cover and remove.

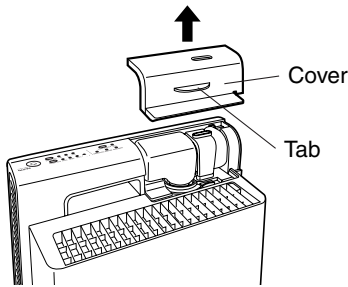

- 2** Remove the tank.
• Lift the tank straight up.

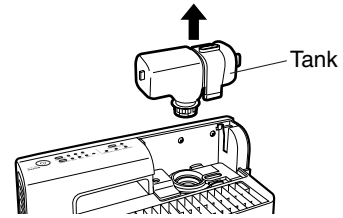

Note:

- Water attached to the cap may drip when removing the tank. Use a towel to ensure that the floor does not get wet.

- 3** Loosen the cap to the tank and fill the tank with tap water (potable).
• Fill the tank with tap water (potable) without overfilling.

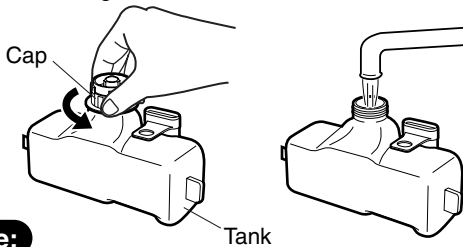

Note:

- Wash the cap well as mold may form on the tank cap.

- 4** Tighten the cap of the tank.
• Confirm that the cap is on securely.

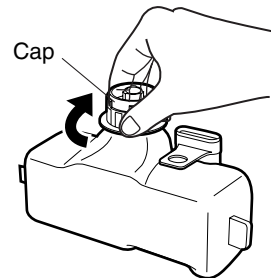

- 5** Replace the tank.
• Line up the tank.

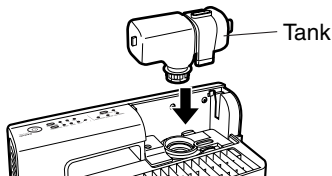

- 6** Replace the cover.
• Press the cover into place matching the configuration.

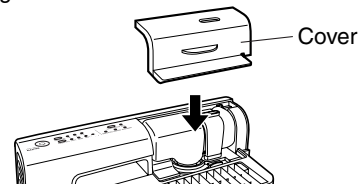

Water

Use water specified in the attached (Notes).

This may hinder proper operation.

Note:

- Only use tap water (potable) below 86°F.
- Mold and bacteria may develop if unspecified water is used and may hinder proper operation.
- Dispose the water in the electrolyzed water unit and tank after removing the power plug. Without electricity, the effect of the electrolyzed water is reduced and mold and bacteria may develop.
- Dispose of the water in the tank if the water has a chance of freezing. If the water freezes, it may cause the device to malfunction.

Unit Installation

Adjusting the Sensitivity of the Odor Sensor

- 1** ① Press the Release buttons (both sides) at the bottom of the unit, ② pull the front cover away from the unit, and ③ lift.

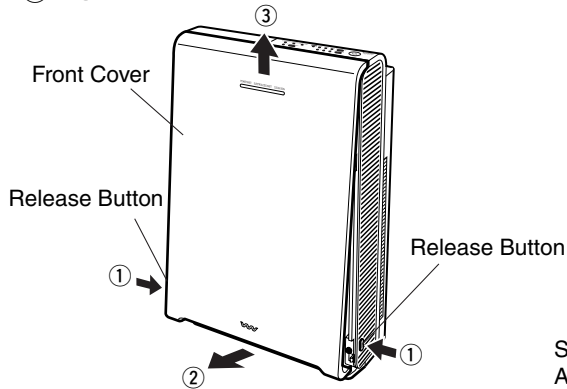

- 2** Adjust the sensor sensitivity adjustment slide tab.

- The tab is set to the middle when shipping. Set the tab to this location during normal operation.
- To operate when even slightly dirty set to "High"
- To operate infrequently set to "Low"

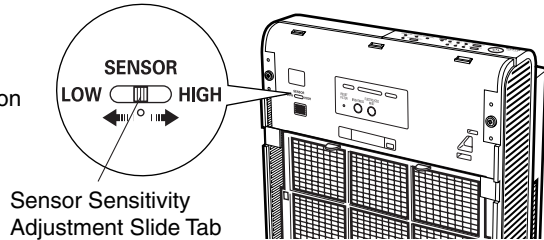

Unit Installation

- 1** Place the unit on a stable and horizontal surface and in a location where the air circulates well around the room.

- This unit operates more effectively when the unit is set in the middle of a wall facing the center of the room.

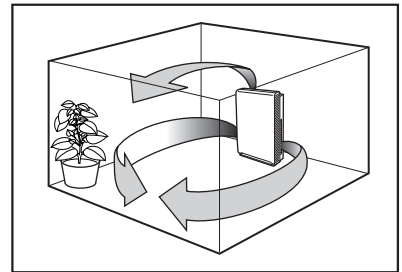

Caution

- Unplug the unit when moving or not using for extended periods and dispose of the water in the electrolyzed water unit and tank (water may spill or mold and bacteria may develop).
- Do not tilt the unit when in use. The electrolyzed water unit may cease to operate properly or water may spill.

Note:

- Do not set in a location where the air inlet or outlet may be covered.
- Ensure that AV equipment, i.e. TV and radios, is located at least 6.5ft away (noise may interfere with the equipment).

- 2** Ventilate the room and clean the air before plugging the cord into the wall outlet.

- After the cord is plugged into the outlet, the Automatic Operating Lamp (Green) turns on for a certain period of time as the device configures the sensor with air cleanliness standards. Once the air is cleaned, the sensor is automatically updated with this condition as the air cleanliness standard.

Method of Use

The device can be operated according to preference. Normally, it is recommended that automatic operation is selected to operate automatically in response to the cleanliness of the air. When the automatic operation, adjust the sensitivity of the odor sensor (refer to page E-7).

1 Press the power on/off button.

- Press the power on/off button to operate in [AUTO/Electrolyzed Water “On”] mode after plugging in the power plug.
- The electrolyzed water and clean lamps turn on.
(The electrolyzed water lamp turns on while operating the electrolyzed water function).

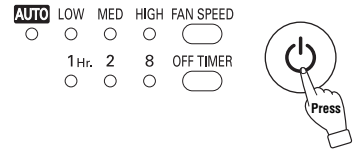

2 Press the fan speed button and operate according to preference.

- The operating mode switches with each press of the button and the mode is indicated by the corresponding lamp.

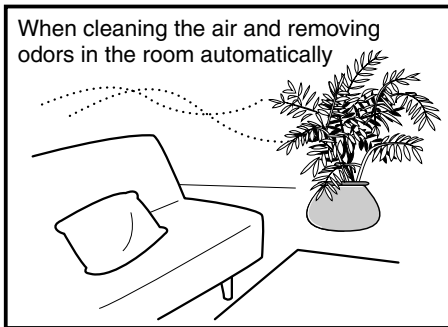
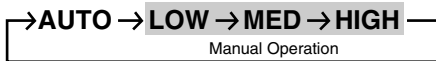
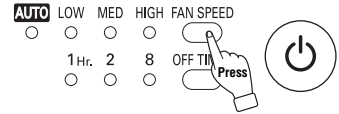

Automatic Operation

- Press the fan speed button and operate in “AUTO”.
- Operates automatically when the odor and dust sensors detect dirt, odor, or dust in the air of the room.
- A sterile, electrolyzed mist is produced (the electrolyzed water function generates a sterile, electrolyzed mist). Press the electrolyzed water button to turn off the electrolyzed water.
- The electrolyzed water function cannot be operated independently.
- * Even when the air of the room is clean, the electrolyzed water function operates silently for about 10 minutes, once every hour, to agitate the water.

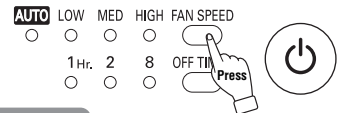

Operation of the Odor and Dust Sensors

The odor and dust sensors operate automatically when set to automatic operation mode.

- The dust sensor responds to cigarette smoke, dust, pollen, and dust mites.
- The odor sensor responds to cigarette smoke, insecticides, cosmetics, alcohol, gases generated by burning appliances, and sudden changes of temperature and humidity.

Color of Clean Indicator and Operating Status (Air flow indicator lamp does not turn on)

Cleanliness		Clean ←————→ Very Dirty		
Color of Clean Indicator		Green	Yellow	Red
Operating Status	Fan	Stop	Low	Medium
	Sterile, Electrolytic Mist	Stop	Low	Low or Strong

The generated volume of sterile, electrolytic mist is intermittent with Low (small) and Strong (large).

Note:

- Toxic substances (carbon monoxide, etc.) from cigarettes cannot be eliminated.
- Odor components (odors from building material, pets, etc.) that are continuously generated cannot be entirely eliminated.

Method of Use

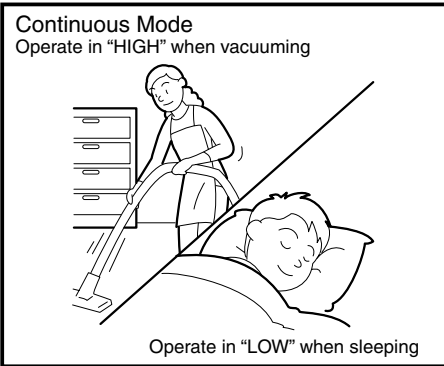

Manual Operation

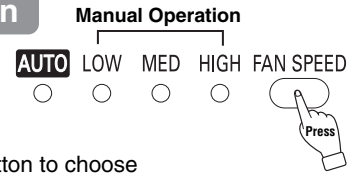

- Press the fan speed button to choose "LOW", "MED", or "HIGH" mode.
- The volume of sterile, electrolytic mist generated during High is strong (large). The volume is low (small) for all other modes. The mist is generated intermittently.
- Press the electrolyzed water button to turn the electrolyzed water function "On" or "Off".

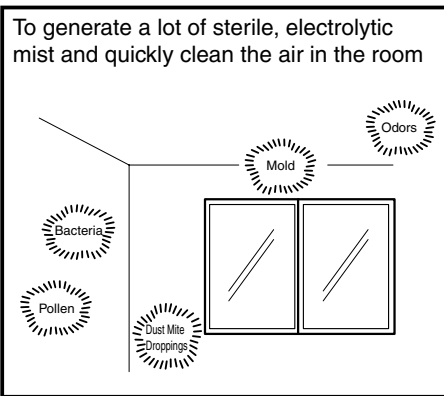

Power Mist Mode

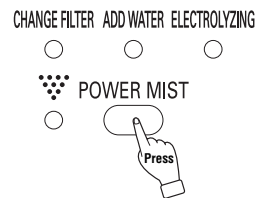

- Press the power mist button to operate in power mist mode.
- High (5 min) → Medium (25 min)
(The air flow indicator does not turn on.)
- A sterile, electrolytic mist is intermittently generated for 30 minutes.
- Once the power mist cycle is complete, the device switches to automatic mode.
- Press the fan speed button to cancel and to switch to a different operating mode.

* When the mode is switched to power mist while the timer is operating, the configured timer cancels.

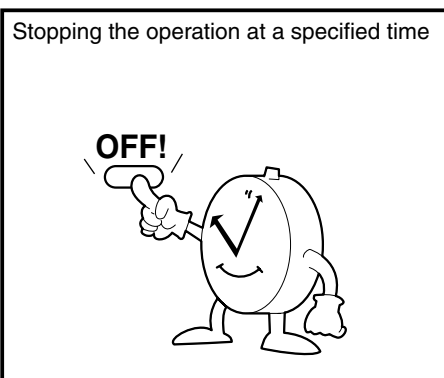

Timer Operation

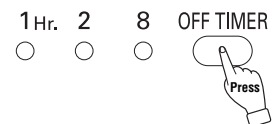

- Press the off timer button and set to a preferred time. Each time the button is pressed, the indicator lamp sets to the timer according to the lamp.

Continuous
→ 1 Hour → 2 Hours → 8 Hours → Operation
(The lamp does not turn on.)

- The indicators change according to the amount of time that has passed and the lights indicate the amount of time remaining.
- Once the pre-determined amount of time passes, the device automatically turns off.
- * The power mist mode cannot be set with a timer.

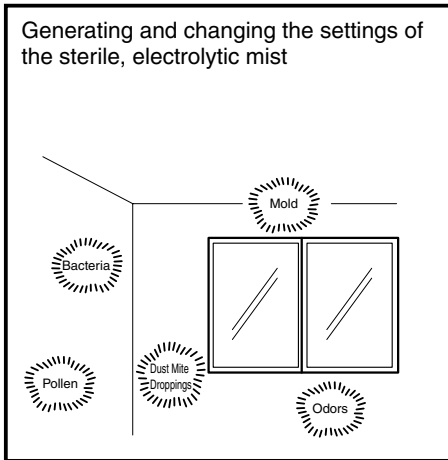

Electrolyzed Water

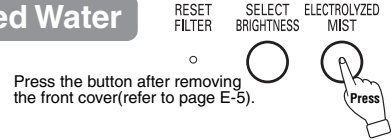

- The electrolyzed water and mistream lamps light when the power on/off button is pressed and a sterile, electrolytic mist is generated.
- The sterile, electrolytic mist is generated intermittently.
- Press the electrolyzed water button to turn the electrolyzed water function "On" or "Off".
- The electrolyzed water function cannot be operated independently.
- The electrolyzed water function cannot be turned on while the power mist is operating.

Note:

- When there is no water in the tank, the add water lamp turns on. Remove the tank and fill the tank with tap water (potable) (refer to page E-6).
- A flashing the add water lamp indicates that an extended period of time has elapsed since filling the tank with water. Remove and clean (refer to page E-13) the electrolyzed water unit and fill the tank with water.
- The add water lamp flashes when the electrolyzed water mode has not been operated for an extended period of time (this is not a malfunction). Remove the tank and replace it after 20 seconds.
- The electrolyzed water lamp flashes when cleaning the water to maintain its sterilizing effect.

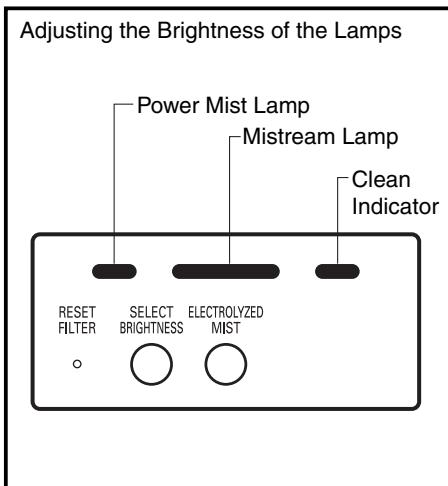

Select Brightness

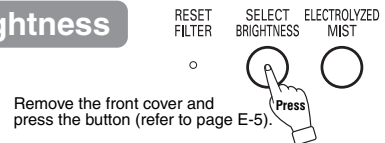

- Press the select brightness button to change the brightness of the lamp (power mist lamp, mistream lamp, and clean indicator).

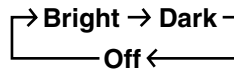

Stopping Operation

Press the power on/off button.
Memory Function

- Press the power on/off button after the operation to return to the previous mode.
- The timer/power mist operations are not placed in memory.
- When the power plug is unplugged, the memory is erased.

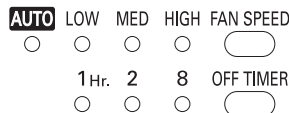

Replacing the Filter

Warning

Always remove the power plug from the wall outlet.

Replacement Periods

■ Although replacement periods differ according to operating modes and installation locations, replace once every 4 years.

- **Filter replacement lamp turns on.**

Prepare a new filter as the filter replacement period approaches.



- **Filter replacement lamp flashes.**

Replace with a new filter.

■ If the color of the filter or dirt changes to the indicated color on the replacement guide label, replace the filter within 4 years.
(Confirm this color when cleaning the pre-filter).

■ Replace the filter within 4 years if there are odors that are not being eliminated.

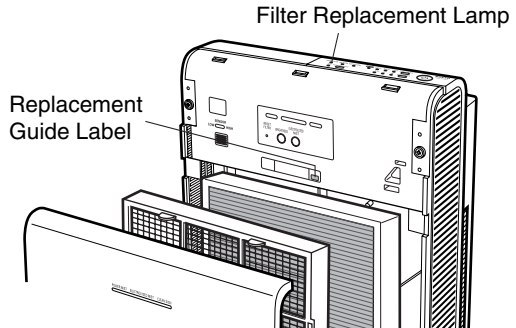

Refer to page E-5 regarding replacement methods.

- Once the filter has been replaced, plug the power plug into the wall outlet, press the filter reset button with something small, i.e. ballpoint pen tip, and confirm that the filter replacement lamp has turned off. Once the lamp has turned off, the microcomputer calculates the new replacement period of the filter.

Note:

- Do not wash the filter.
Do not reuse the filter even after washing.

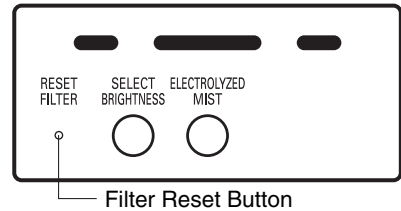

The life of the filter is greatly reduced by the following.

(Even if the filter replacement lamp does not turn on, replace the filter.)

- If oily smoke or carbonaceous materials (i.e. soot) are drawn in.
- If the device is always used on high in a room with particularly dirty air or with strong odors.
- If the pre-filter has not been installed.

Replacement Filter

- Purchase this filter at a store selling Sanyo commercial devices.

Filter No. ABC-FAH94A The life of the filter is about 4 years.

Cleaning Methods

Warning

Always remove the power plug from the wall outlet.

Note:

- Do not tilt the unit when cleaning. Water from the tank and electrolyzed water unit will spill.
- Do not use kerosene, paint thinner, or any other solvents or polishing powders. This may cause scratches, discoloration, and cracks.

Unit

- Soak a soft cloth in diluted neutral kitchen detergent, wring it dry, and wipe.
Use a vacuum cleaner to remove dust from the air inlet and outlet.
Lastly, wipe with a dry cloth.

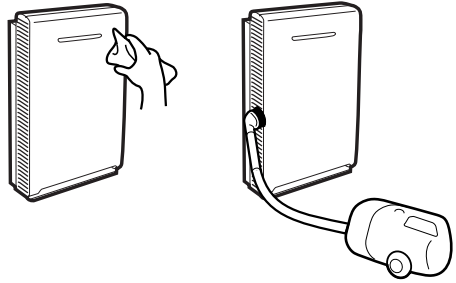

Pre-filter

- Remove the front cover and pre-filter (refer to page E-5).
- Use a vacuum cleaner to remove dust.
- Wash with water if extremely dirty and dry completely.

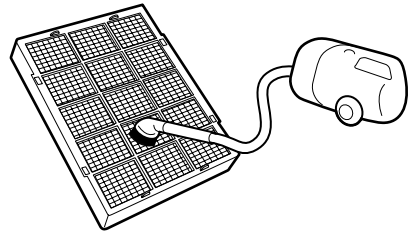

Filter

It is recommended that the filter is cleaned once per year to ensure the air is effectively cleaned.

- Use a vacuum cleaner to remove any dust from the surface of the filter. Ensure that the filter does not tear when the mouth of the vacuum cleaner is firmly pressed against the filter. (Remove the filter after removing the front cover and pre-filter. Refer to page E-5.)
- Do not wash the filter. Do not reuse the filter even after washing.

Odor/Dust Sensors

- Clean the dust by using a vacuum cleaner.
It is recommended that the device is cleaned once every 3-6 months. (Remove the front cover. Refer to page E-5.)

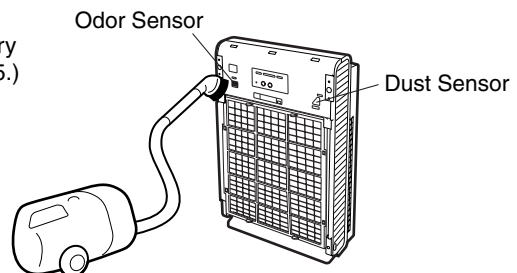

Continue in the following

Cleaning Methods

Warning

Always remove the power plug from the wall outlet.

Electrolyzed Water Unit/Tank

1 Remove the cover, tank, and electrolyzed water unit.

- Lift the tank straight up.

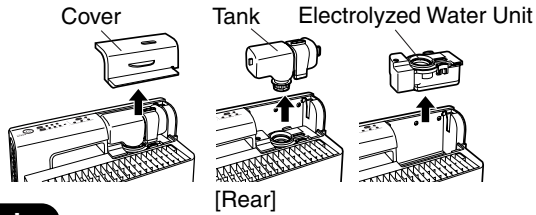

Note:

- Use a towel to ensure that the floor does not get wet from water attached to the electrolyzed water unit and tank.

2 Remove the electrolyzed water cover.

- Remove the cover from both sides (lift to remove the electrolyzed water cover).

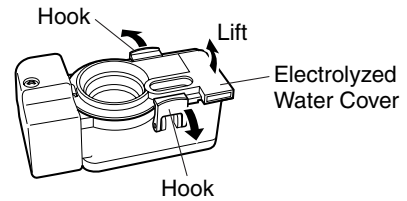

3 Wash the tank and electrolyzed water cover with water.

- Rinse clean with water. Use a toothbrush to remove the dirt if extremely dirty.

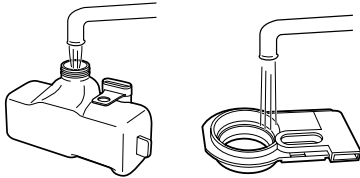

4 Use a cotton swab to remove any dirt from the sterile, electrolytic mist generator of the electrolyzed water unit. (Do not wash with water. This may cause the unit to malfunction.)

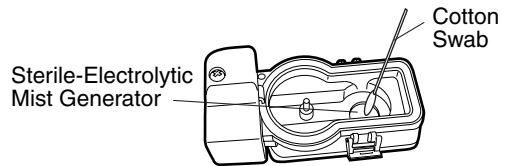

5 Wipe off any water and dry completely.

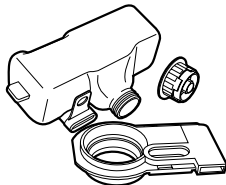

6 Re-assemble the electrolyzed water unit and replace.

- Place the side tabs of the electrolyzed water unit cover to the bottom and press the hooks on both sides.

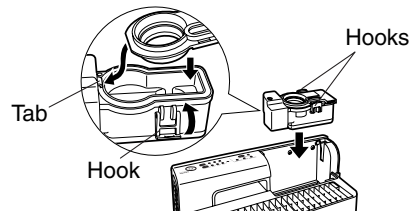

7 Close the cap on the tank and replace.

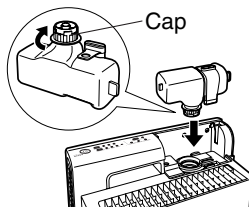

8 Replace the cover.

- Push from above.

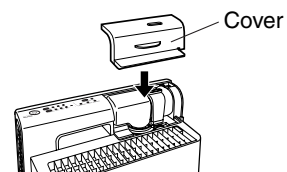

Note:

- Do not wash any other components except the tank and electrolyzed water unit. This may cause an electric shock or malfunction.
- Do not use detergents. This may cause malfunctions.

Troubleshooting

Warning

- If the device is still operating abnormally after inspecting the following, stop using the device to prevent accidents, unplug the power plug from the wall outlet and consult the place of purchase.
- Do not attempt to repair at home as this may be dangerous.

Condition	Inspect	Repair
Does not operate.	<ul style="list-style-type: none"> ● Is the power plug securely in the wall outlet? 	<ul style="list-style-type: none"> ● Place the power plug securely in the wall outlet.
Smoke and odors are not removed.	<ul style="list-style-type: none"> ● Are the filter and pre-filter installed? 	<ul style="list-style-type: none"> ● Install the filter and pre-filter.
	<ul style="list-style-type: none"> ● Has the plastic protector on the filter been removed? 	<ul style="list-style-type: none"> ● Remove the plastic protector on the filter.
	<ul style="list-style-type: none"> ● Is the filter or pre-filter dirty? ● Is the filter replacement lamp flashing? 	<ul style="list-style-type: none"> ● Replace the filter or clean the pre-filter.
	<ul style="list-style-type: none"> ● Is the air inlet dirty and blocked? 	<ul style="list-style-type: none"> ● Clean the air inlet.
The clean indicator is continuously red.	<ul style="list-style-type: none"> ● Is the air very dirty? ● Are any insecticides or cosmetic devices that may trigger the sensor being used? 	<ul style="list-style-type: none"> ● Ventilate the room.
	<ul style="list-style-type: none"> ● Is the sensor sensitivity adjustment slide tab set to "HIGH"? 	<ul style="list-style-type: none"> ● Set the sensor sensitivity adjustment slide tab to "Mid" or "LOW".
The add water lamp is on.	<ul style="list-style-type: none"> ● Is there water in the tank? 	<ul style="list-style-type: none"> ● Fill the tank with tap water (potable). ● Remove the tank and replace after waiting 20 seconds.
The add water lamp is flashing.	<ul style="list-style-type: none"> ● It is time to replace the water. ● The electrolyzed water function has not been used for an extended period of time. 	<ul style="list-style-type: none"> ● Clean the electrolyzed water unit and replace the water in the tank. ● Remove the tank and replace after waiting 20 seconds.
Water is leaking.	<ul style="list-style-type: none"> ● Has the cap been placed correctly on the tank? 	<ul style="list-style-type: none"> ● Retighten the cap correctly.
	<ul style="list-style-type: none"> ● Has the electrolyzed water unit been properly installed? 	<ul style="list-style-type: none"> ● Install the electrolyzed water unit properly.
There is an odor of chlorine.	<ul style="list-style-type: none"> ● This is from the electrolyzed water and is not a malfunction. 	
The sterile, electrolytic mist is not emitted.	<ul style="list-style-type: none"> ● Has the electrolyzed water unit and tank been properly installed? ● Is the electrolyzed water button turned "Off"? ● Is the water level in the electrolyzed water unit high? 	<ul style="list-style-type: none"> ● Ensure that the installation is correct. ● Press the electrolyzed water button to turn "On". ● Replace the water in the electrolyzed water unit.
The Electrolyzed Water lamp is flashing.	<ul style="list-style-type: none"> ● The Electrolyzed Water lamp flashes when cleaning the water to maintain its sterilizing effect. The Water Cleaning function operates once every 8 hours for about 4 minutes. 	
Does not operate even when the air is dirty.	<ul style="list-style-type: none"> ● The automatic operation lamp (green) is flashing. 	<ul style="list-style-type: none"> ● The sensor is configuring the air cleanliness standard. This is not a malfunction.
	<ul style="list-style-type: none"> ● Is the sensor sensitivity adjustment slide tab set to "Mid" or "LOW"? 	<ul style="list-style-type: none"> ● Set the sensor sensitivity adjustment slide tab to "Mid" or "HIGH".
	<ul style="list-style-type: none"> ● Is the air inlet dirty and blocked? 	<ul style="list-style-type: none"> ● Clean the air inlet.

Specifications

Power supply voltage	: 220 - 230 V	Protection class	: II
Frequency	: 50 Hz	Net weight	: 7.1 kg
Power consumption	: 50 W		